

# Montageanleitung

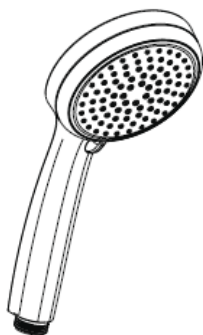

**Croma 100  
Vario**  
28535000



**Croma 100  
Multi**  
28536000

**hangrohe**

**Croma 100 Vario**  
28535000

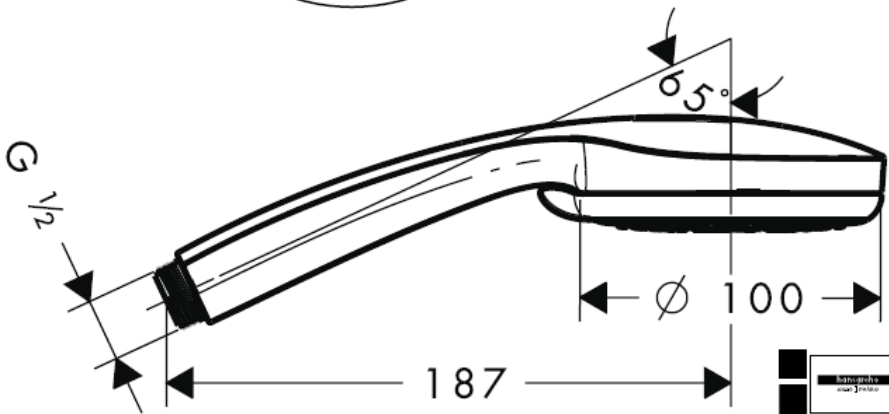
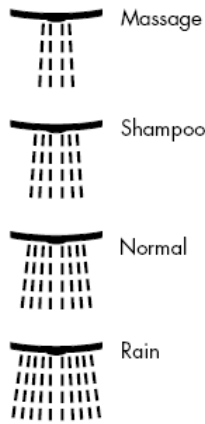

28535000

**Croma 100 Multi**  
28536000

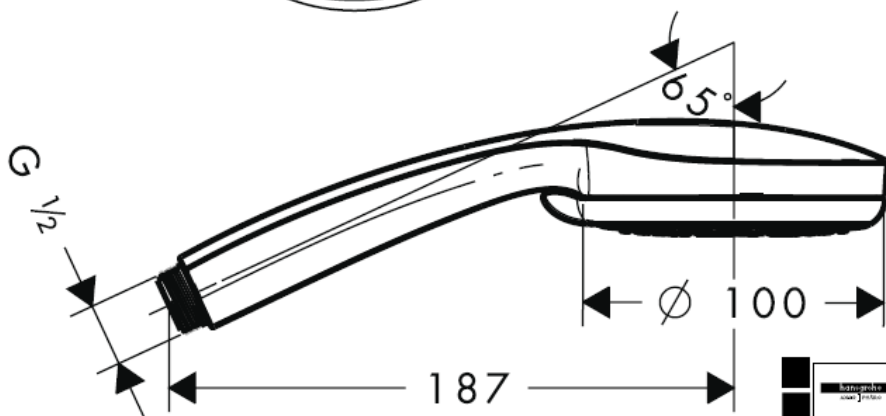
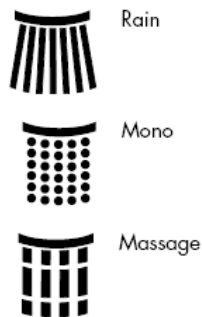

28536000

**Technische Daten**

Betriebsdruck: max. 0,6 MPa  
 Empfohlener Betriebsdruck: 0,1 – 0,4 MPa  
 (1 MPa = 10 bar = 147 PSI)  
 Heißwassertemperatur: max. 60° C

	DVGW	P-IX	SVGW	ACS	NF	WRAS	KIWA
28535000		P-IX 18335/ID	X	X			X
28536000		P-IX 18336/ID	X	X			X

**Montage**

Der beige packte Filtereinsatz (A) muss eingebaut werden, um den Normdurchfluss der Handbrause zu gewährleisten und um Schmutzeinspülungen aus dem Leitungsnetz zu vermeiden. Wird ein größerer Wasserdurchfluss gewünscht, muss anstelle des Filtereinsatzes (A) die Siebdichtung (B) eingesetzt werden.

Schmutzeinspülungen können die Funktion beeinträchtigen und/oder zu Beschädigungen an Funktionsteilen der Handbrause führen, für hieraus ergebende Schäden haftet Hansgrohe nicht.

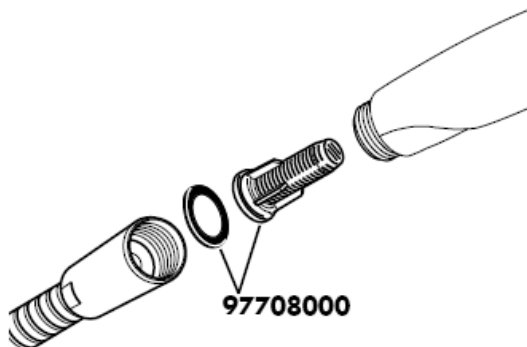

## Croma 100 Vario



Ab • ist die Funktion gewährleistet.

## Croma 100 Multi

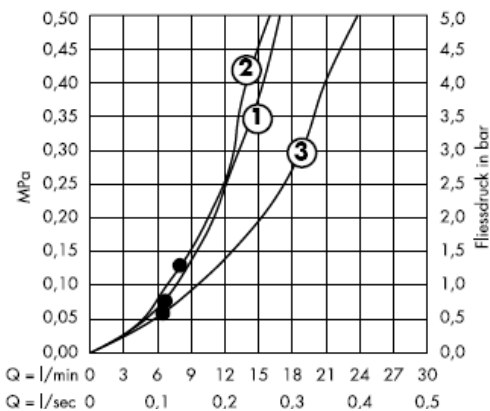

Ab • ist die Funktion gewährleistet.

Die Handbrause ist für den Einsatz mit Durchlauferhitzern ab einer Leistung von 21 kW und einem Mindestdurchfluss von 7 l/min geeignet.

## Reinigung

Mit Rubit®, der manuellen Reinigungsfunktion können die Strahlformer durch einfaches rubbeln vom Kalk befreit werden.

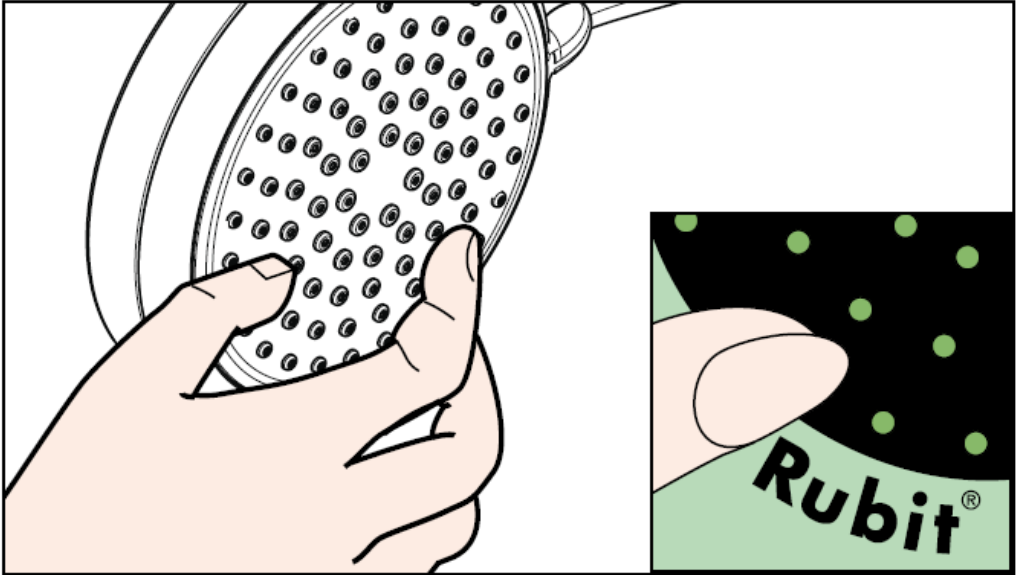

## Reinigung

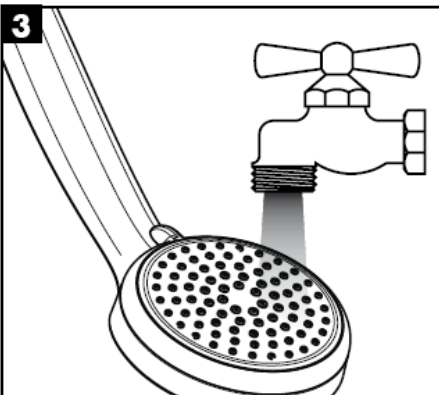
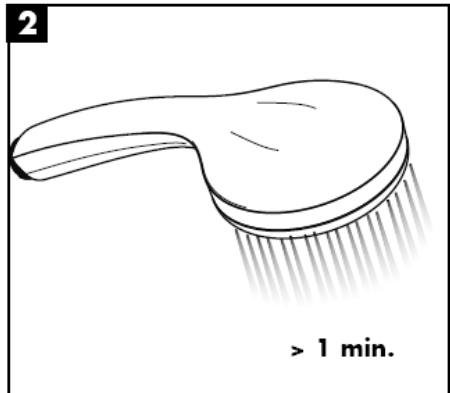
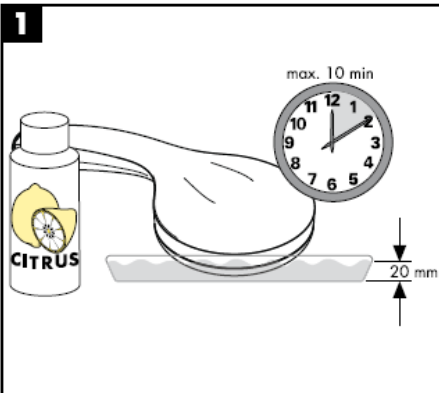
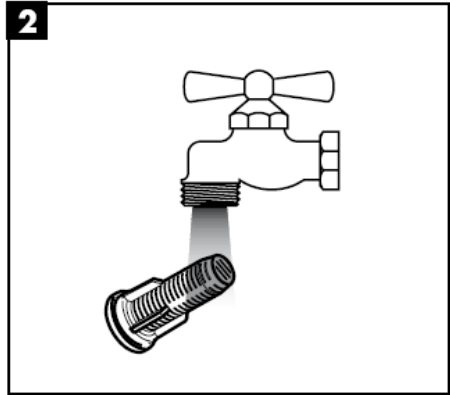
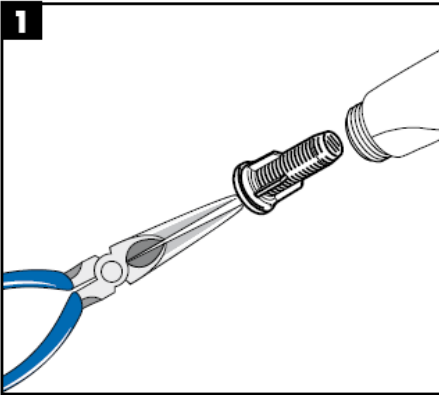

**hansgrohe**





# Instructions de montage

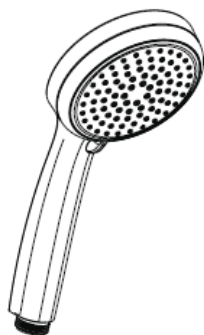

**Cromo 100  
Vario**  
28535000



**Cromo 100  
Multi**  
28536000

**hansgrohe**

**Croma 100 Vario**  
28535000

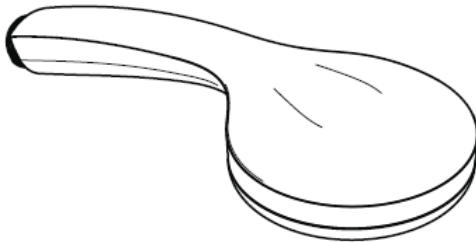

Massage



Shampoo



Normal



Rain

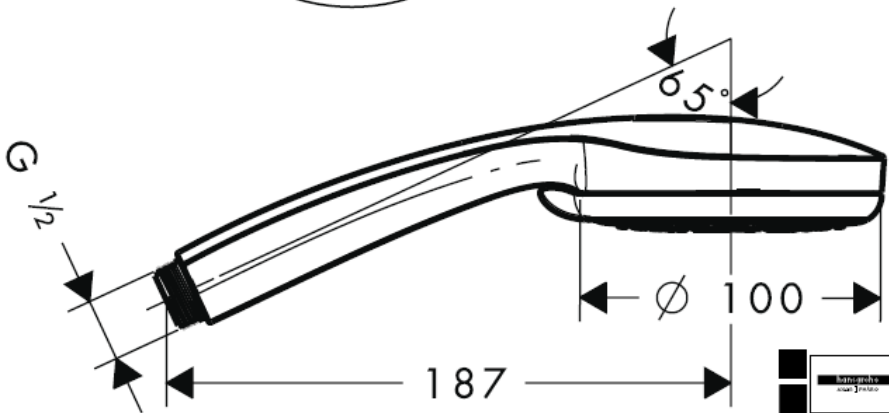

28535000

**Croma 100 Multi**  
28536000

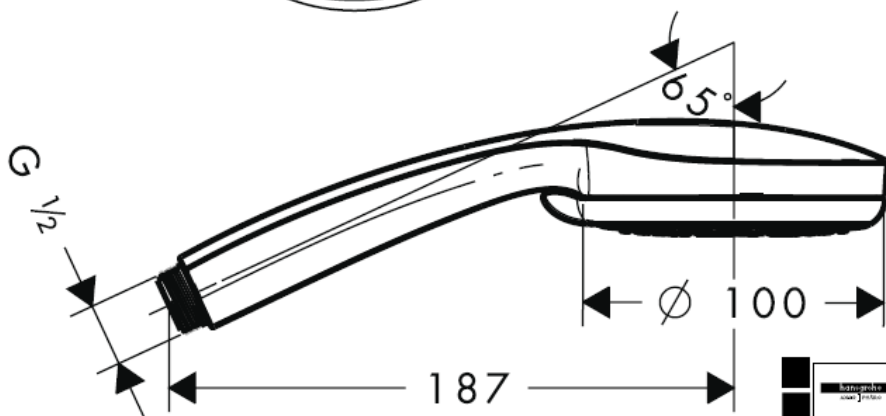
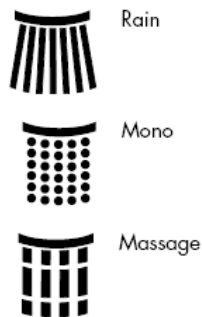

28536000

**Informations techniques**

Pression de service autorisée: max. 0,6 MPa  
 Pression de service conseillée: 0,1 – 0,4 MPa  
 (1 MPa = 10 bars = 147 PSI)  
 Température max. d'eau chaude: max. 60° C

	DVGW	P-IX	SVGW	ACS	NF	WRAS	KIWA
28535000		P-IX 18335/ID	X	X			X
28536000		P-IX 18336/ID	X	X			X

**Montage**

L' élément-filtre (A) , pièce jointe, doit être installé pour garantir le débit normalisé et pour éviter l' infiltration d' impuretés venant du réseau. Si l' on désire un débit plus important, il faut remplacer l' élément-filtre (A) par le joint-filtre (B).

L' infiltration d' impuretés peut réduire ou détériorer le fonctionnement de la douchette, Hansgrohe ne se porte pas garant pour les dommages en résultant.

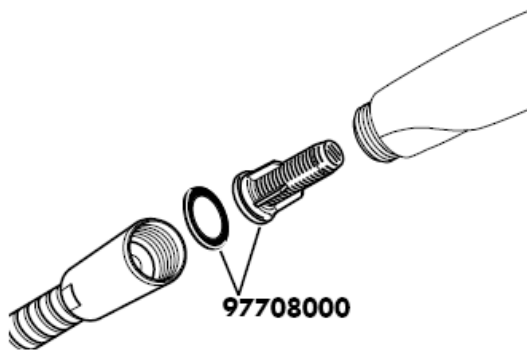

## Croma 100 Vario



A partir de • le fonctionnement est garanti.

## Croma 100 Multi

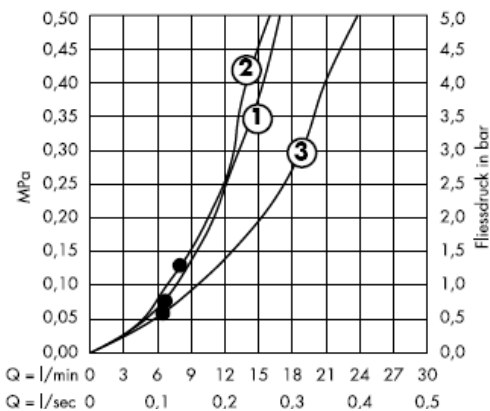

A partir de • le fonctionnement est garanti.

La douche à main fonctionne avec chauffe-eau à partir de 21 kW et un débit minimum de 7 l/min.

## Nettoyage

La pomme de douche est équipée de Rubit®, le système anticalcaire manuel. Les dépôts de calcaire s'enlèvent en frottant avec un doigt ou avec une éponge sur les ouvertures de jets élastiques.

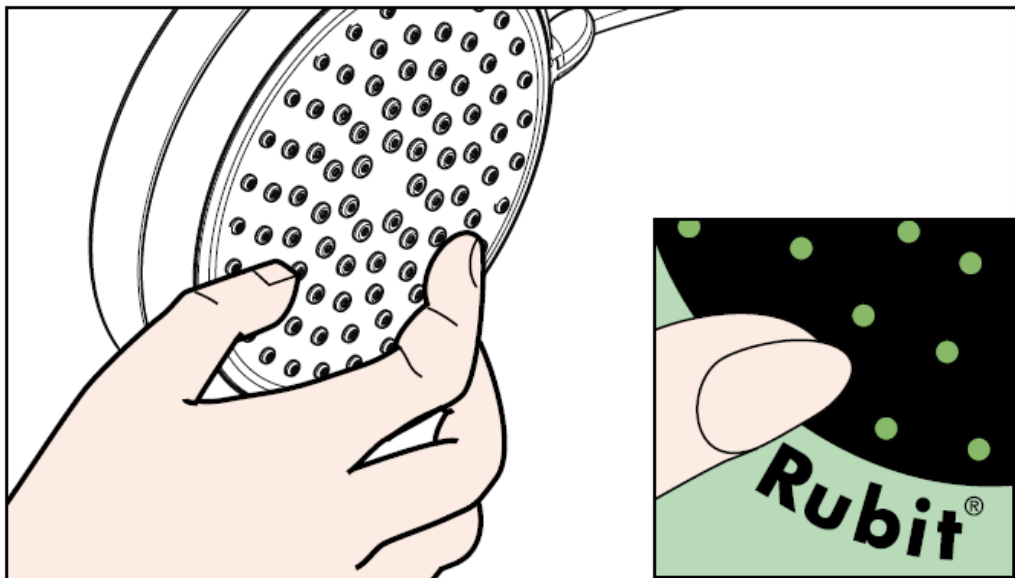

## Nettoyage

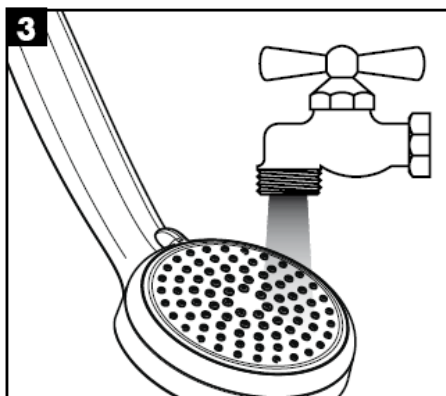
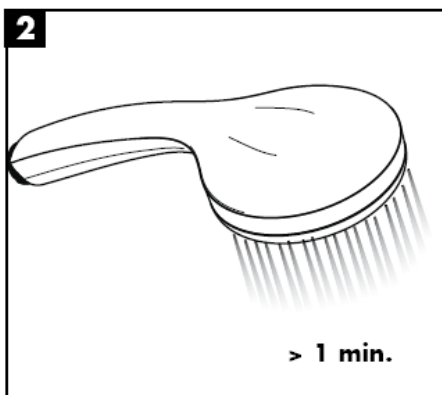
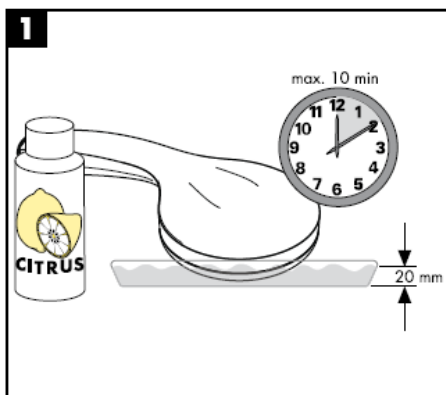
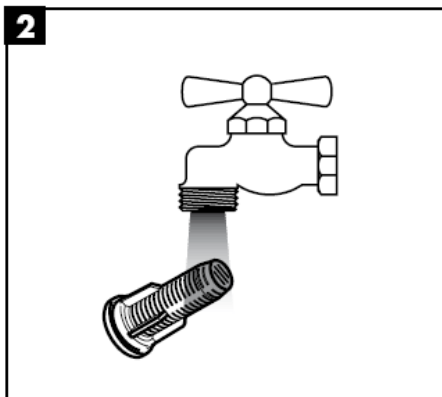
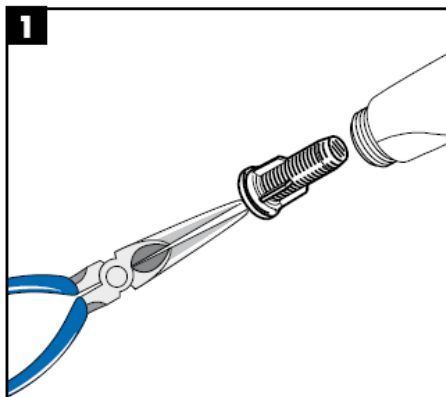

**hansgrohe**





# assembly instructions

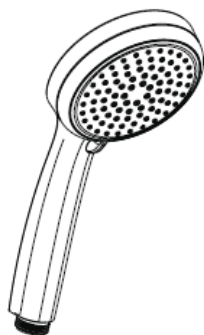

**Cromo 100  
Vario**  
28535000



**Cromo 100  
Multi**  
28536000

**hansgrohe**

**Croma 100 Vario**  
28535000

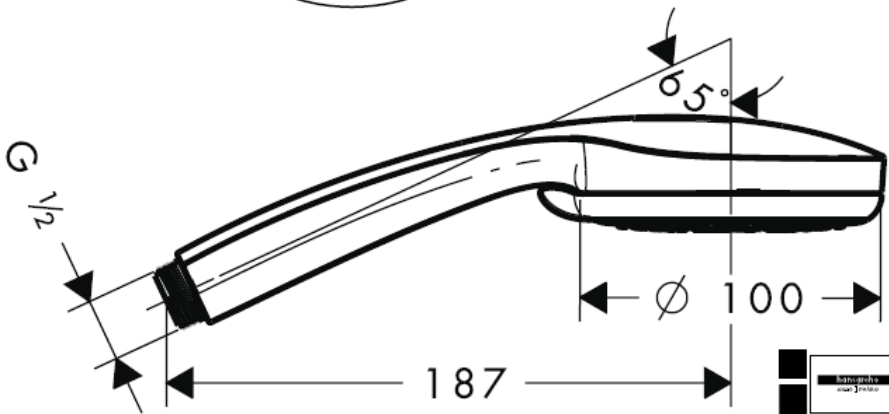
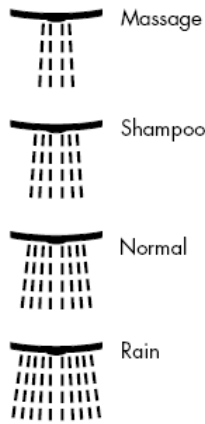

28535000

**Croma 100 Multi**  
28536000



Rain



Mono



Massage

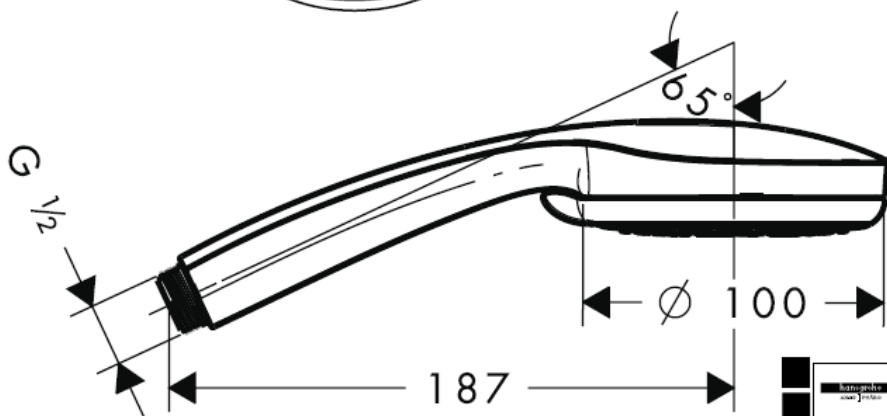

28536000

**Technical Data**

Operating pressure: max. 0,6 MPa  
 Recommended operating pressure: 0,1 – 0,4 MPa  
 (1 MPa = 10 bars = 147 PSI)  
 Hot water temperature: max. 60° C

	DVGW	P-IX	SVGW	ACS	NF	WRAS	KIWA
28535000		P-IX 18335/ID	X	X			X
28536000		P-IX 18336/ID	X	X			X

**Assembly**

The filter insert (A) must be used to ensure the standard flow rate and to protect the hand shower against incoming dirt by pipework. Do you want a larger water flow rate, then you must use the filter packing (B) instead of the filter insert (A).

Incoming dirt leads to defects or/and can damage parts of the hand shower; such caused faults voids all liability and guarantee claims.

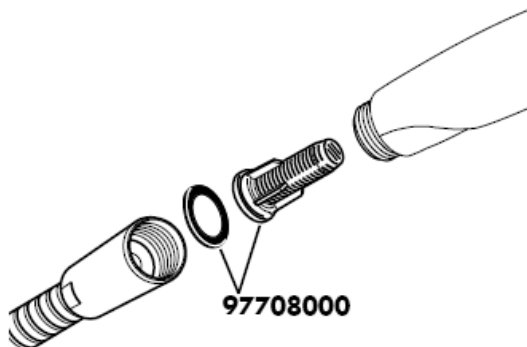

## Croma 100 Vario



From • the function is guaranteed.

## Croma 100 Multi

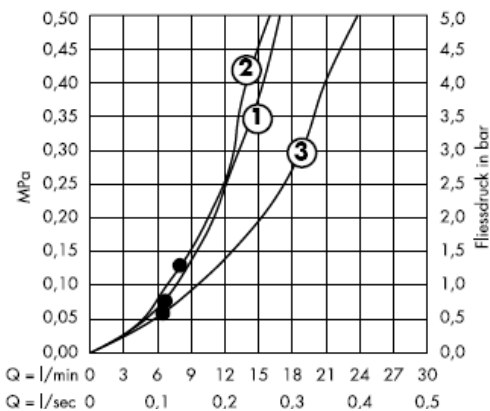

From • the function is guaranteed.

The hand shower is suitable for continuous flow water heaters with a heat output of 21 kW and a minimum through flow of 7 l/minute.

## Cleaning

---

The Rubit® cleaning function only needs a small manual rub over to remove the lime scale from the spray channels.

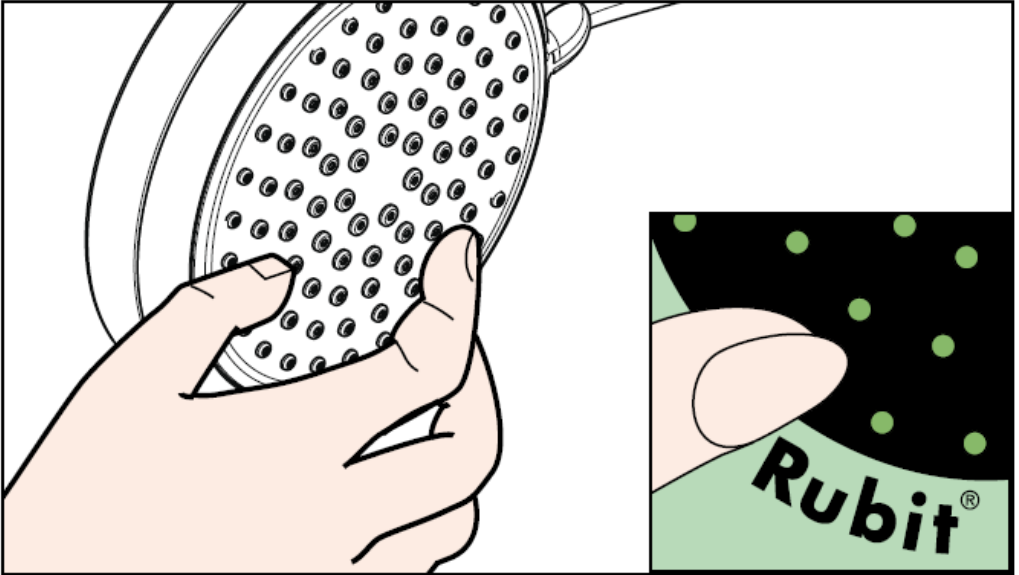

## Cleaning

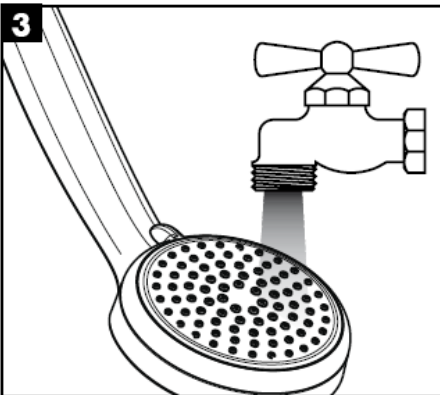
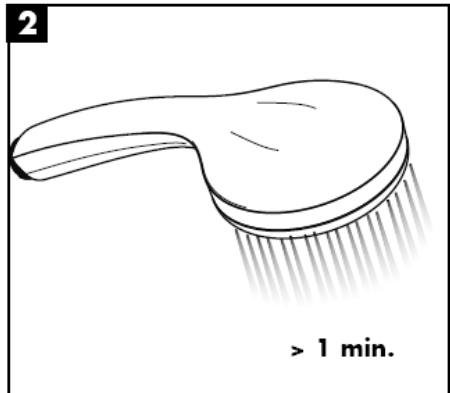
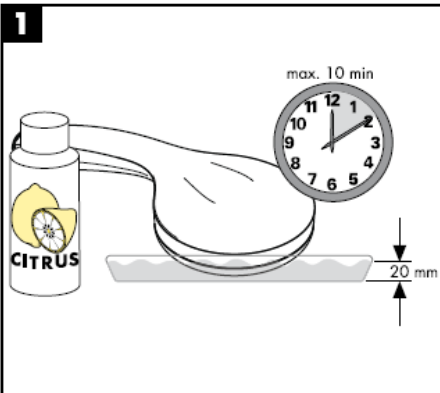
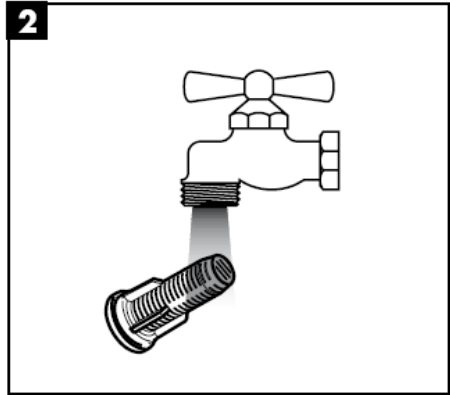
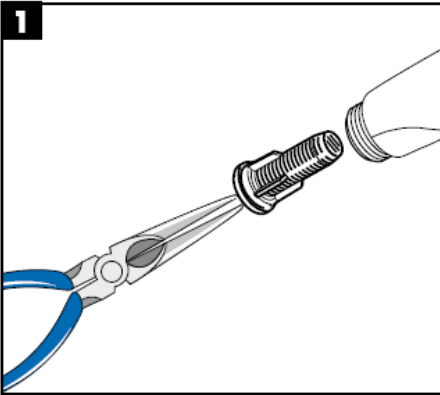

**hansgrohe**





# Istruzioni per Installazione

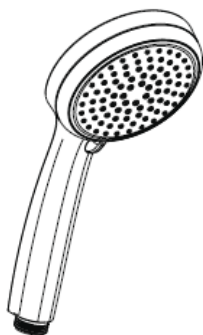

**Cromo 100  
Vario**  
28535000



**Cromo 100  
Multi**  
28536000

**hansgrohe**

**Croma 100 Vario**  
28535000



Massage



Shampoo



Normal



Rain

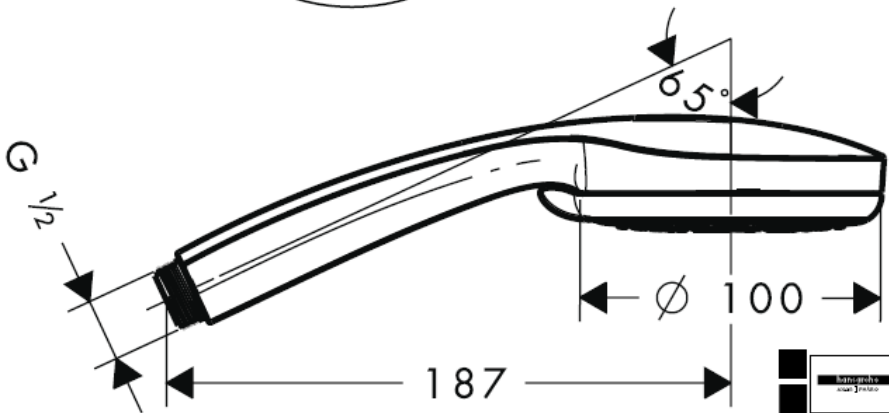

Intertek  
UL  
DIN 4109  
P-IX 18335/ID  
LGA  
Lombardweg 100, 40476 Düsseldorf, Germany

28535000

**Croma 100 Multi**  
28536000



Rain



Mono



Massage

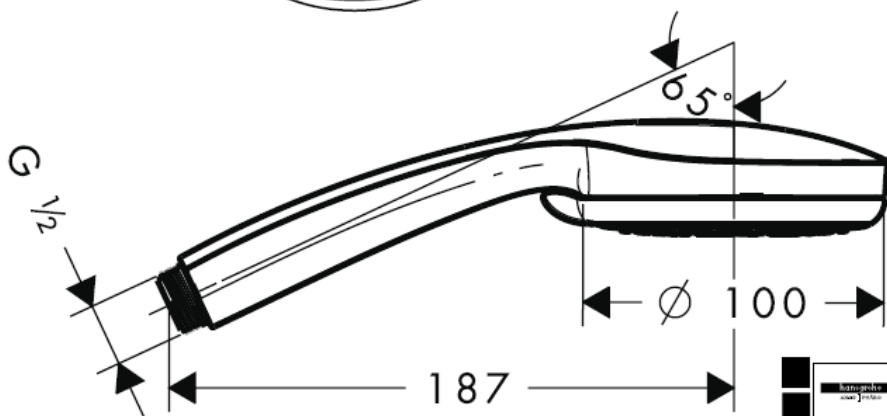

28536000

**Dati tecnici**

Pressione d'uso: max. 0,6 MPa  
 Pressione d'uso consigliata: 0,1 – 0,4 MPa  
 (1 MPa = 10 bar = 147 PSI)  
 Temperatura dell'acqua calda: max. 60° C

	DVGW	P-IX	SVGW	ACS	NF	WRAS	KIWA
28535000		P-IX 18335/ID	X	X			X
28536000		P-IX 18336/ID	X	X			X

**Montaggio**

Il filtro supplementare (A) deve essere utilizzato per assicurare il normale flusso dell'acqua e proteggere la doccia dai depositi di calcare.

Se volete un flusso d'acqua maggiore dovete usare il filtro dell'imballaggio(B) invece del filtro supplementare(A).

Lo sporco in entrata può danneggiare le parti della doccia; questo é motivo di molte lamentele del cliente.

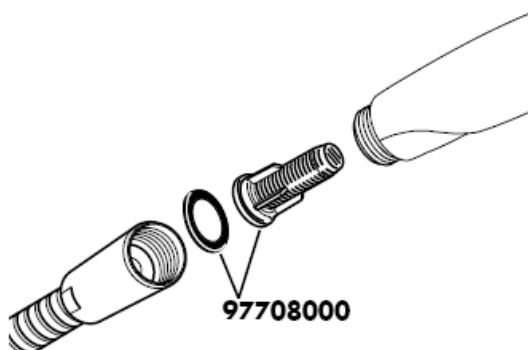

## Croma 100 Vario



Dal • si garantisce la funzionalità.

## Croma 100 Multi

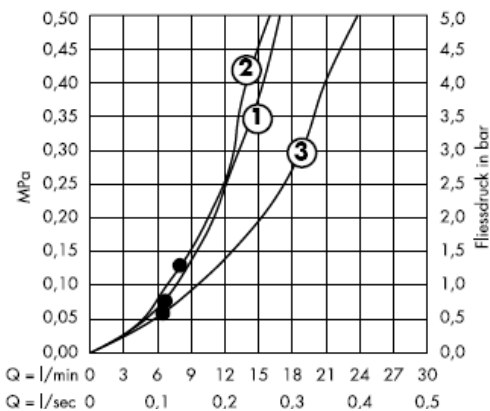

Dal • si garantisce la funzionalità.

La doccia è adatta all'uso con caldaie istantanee da 21 kW con portata minima die 7 l/min.

Con Rubit®, la funzione anticalcare manuale, i diffusori del getto possono essere liberati da calcare con un semplice strofinamento.

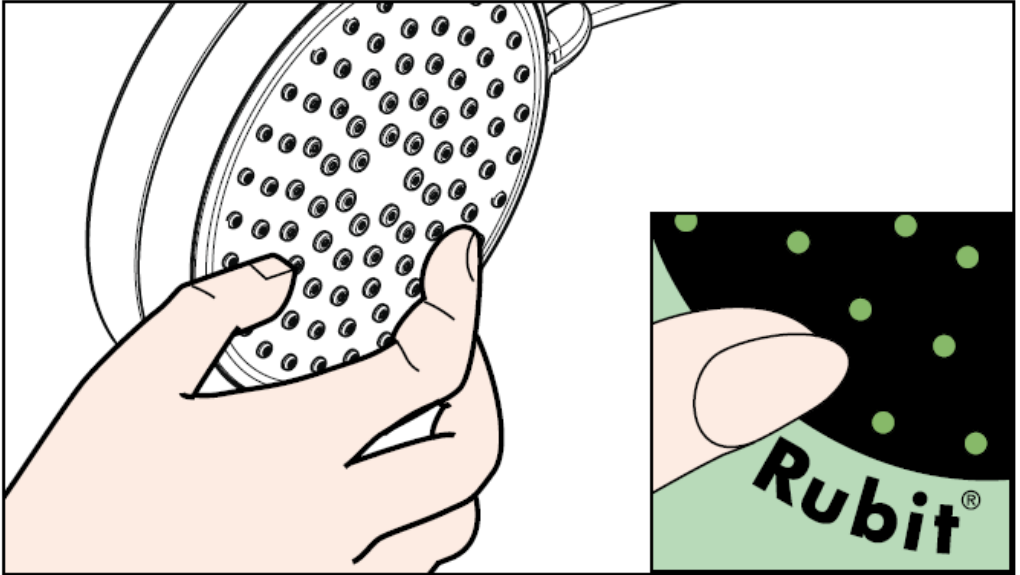

## Pulitura

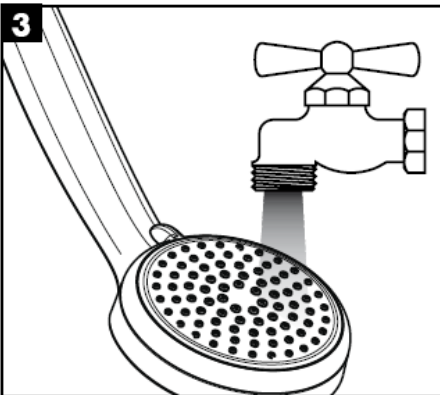
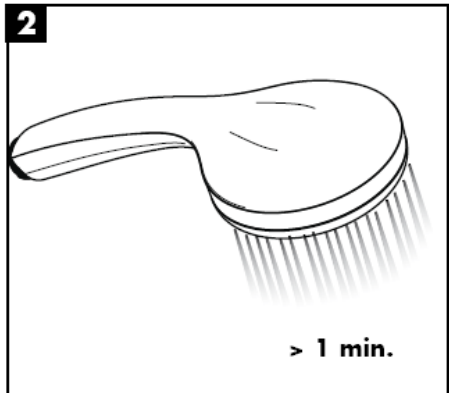
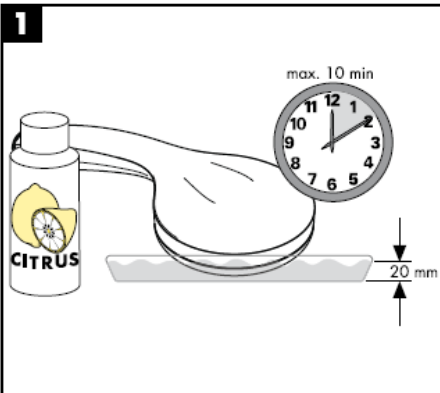
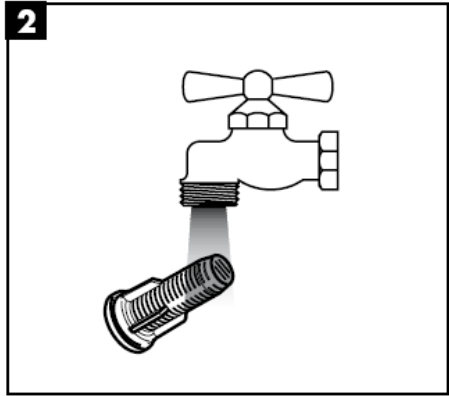
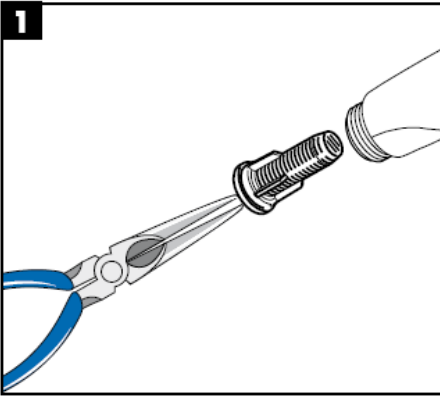

**hansgrohe**





# Instrucciones de montaje

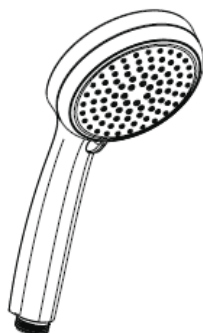

**Cromo 100  
Vario**  
28535000

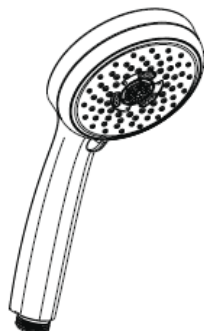

**Cromo 100  
Multi**  
28536000

**hansgrohe**

**Croma 100 Vario**  
28535000



Massage



Shampoo



Normal



Rain

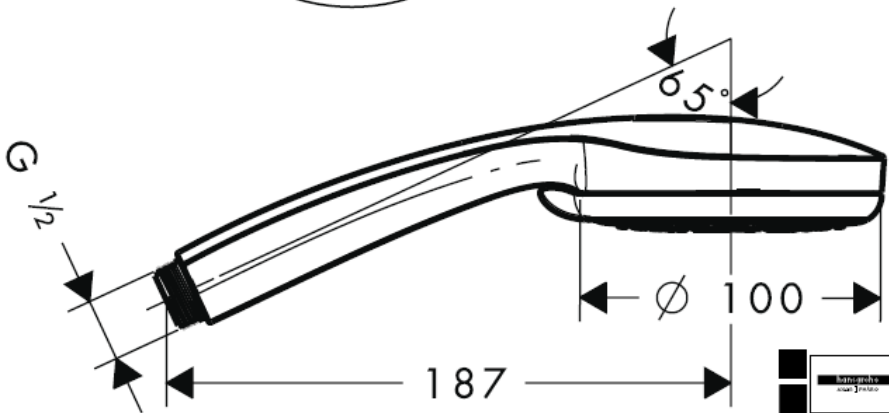

28535000

**Croma 100 Multi**  
28536000



Rain



Mono



Massage

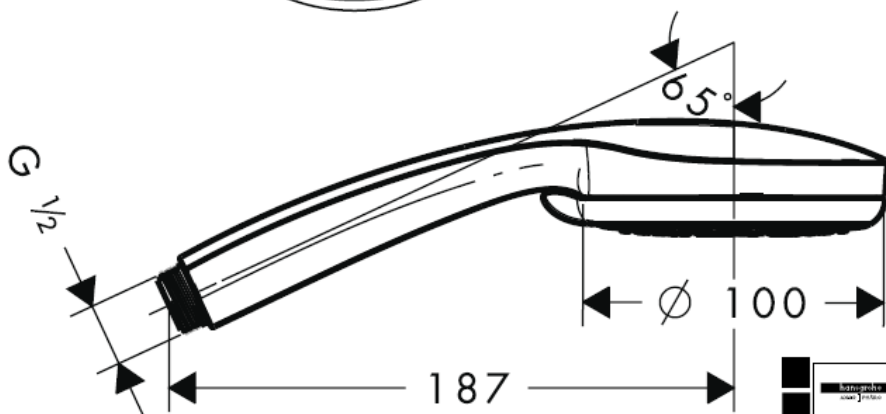

28536000

**Datos técnicos**

Presión en servicio: max. 0,6 MPa  
 Presión recomendada en servicio: 0,1 – 0,4 MPa  
 (1 MPa = 10 bares = 147 PSI)  
 Temperatura del agua caliente: max. 60° C

	DVGW	P-IX	SVGW	ACS	NF	WRAS	KIWA
28535000		P-IX 18335/ID	X	X			X
28536000		P-IX 18336/ID	X	X			X

**Montaje**

La inserción del filtro (A) debe usarse para asegurar el caudal estandar y para proteger la ducha de la suciedad proveniente de las tuberías. Si se quiere un caudal mayor, se debe usar el paquete de filtro (B) en lugar de la inserción de filtro (A).

La suciedad puede producir defectos y/o puede dañar partes de la cabecera de la ducha. Por dichos defectos o fallos Hansgrohe no se hace responsable.

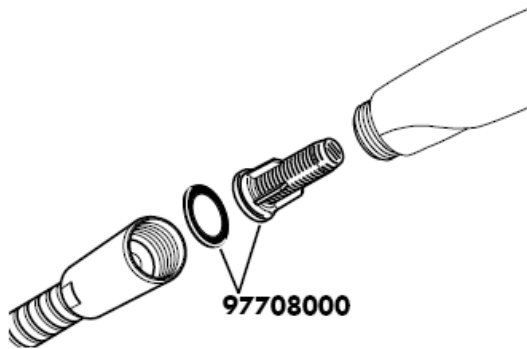

## Croma 100 Vario



Mínimo • para el correcto funcionamiento.

## Croma 100 Multi

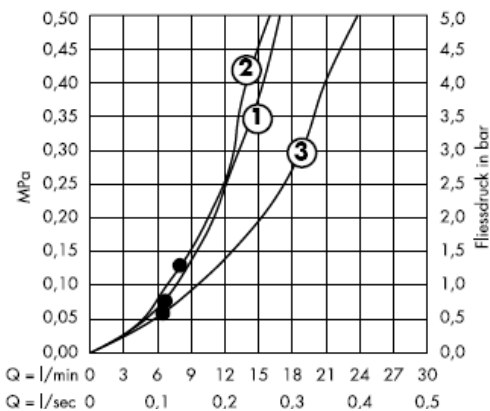

Mínimo • para el correcto funcionamiento.

La teleducha se puede instalar con un calentador continuo de 21 kW de potencia o superior y un caudal mínimo de 7 l/min.

## Limpiar

Rubit®, la función de limpieza manual, permite quitar la cal simplemente frotando los ejectores.

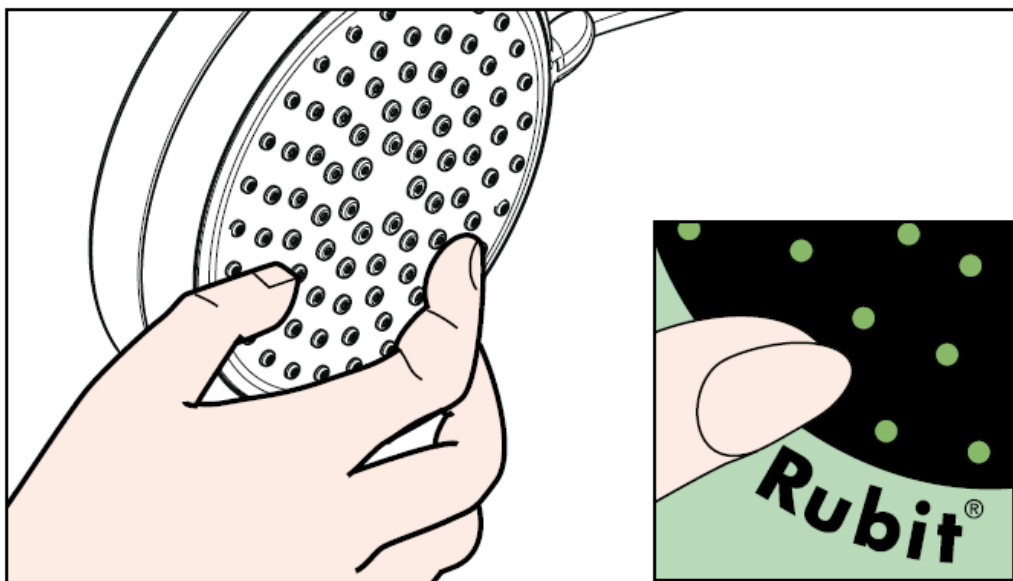

# Limpiar

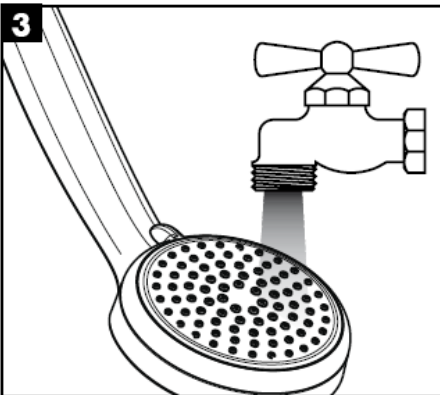
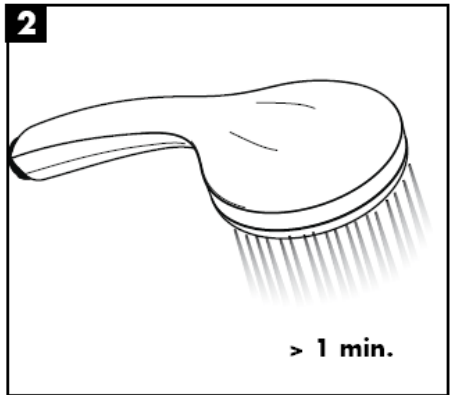
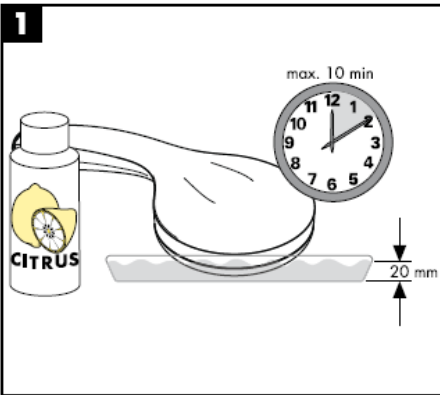
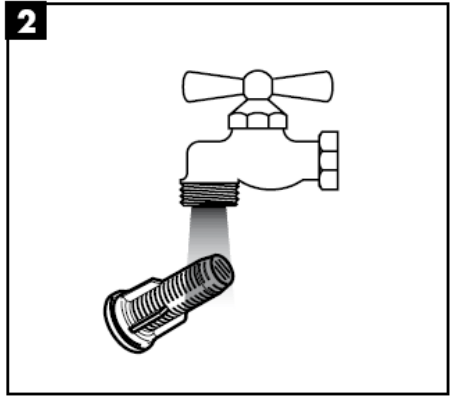
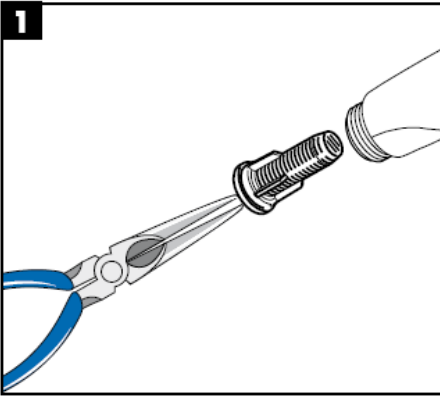

**hansgrohe**





# Handleiding

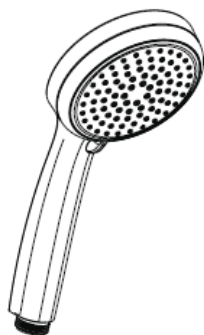

**Cromo 100  
Vario**  
28535000



**Cromo 100  
Multi**  
28536000

**hansgrohe**

**Croma 100 Vario**  
28535000



Massage



Shampoo



Normal



Rain

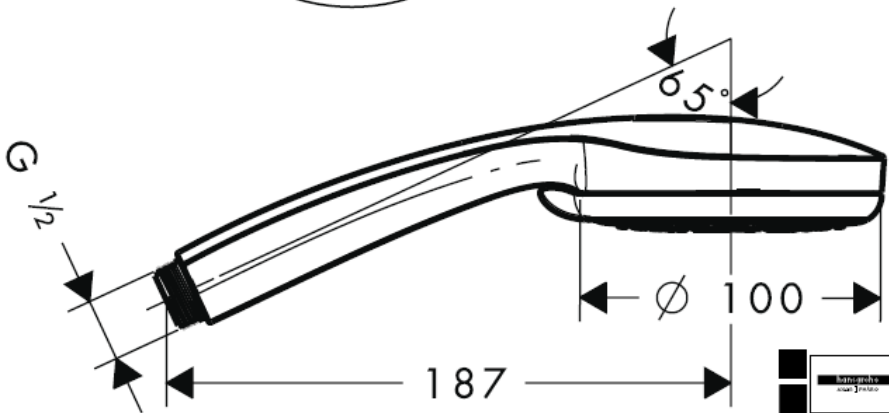

28535000

**Croma 100 Multi**  
28536000



Rain



Mono



Massage

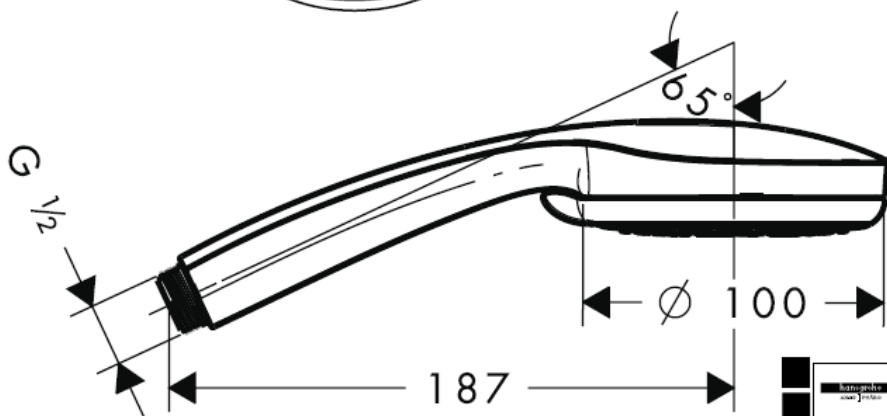

28536000

**Technische gegevens**

Werkdruk: max. max. 0,6 MPa  
 Aanbevolen werkdruk: 0,1 – 0,4 MPa  
 (1 MPa = 10 bar = 147 PSI)  
 Temperatuur warm water: max. 60° C

	DVGW	P-IX	SVGW	ACS	NF	WRAS	KIWA
28535000		P-IX 18335/ID	X	X			X
28536000		P-IX 18336/ID	X	X			X

**Montage**

De bijgeleverde filter (A) moet ingebouwd worden om de norm doorstroom van de handdouche te garanderen en vuil uit de leidingen tegen te houden. Als er een grotere waterdoorlaat gewenst wordt moet i.p.v. het filter de dichting geplaatst worden. Vuil uit de leidingen kan schade aan de handdouche veroorzaken. Op deze schade geeft Hansgrohe geen garantie.

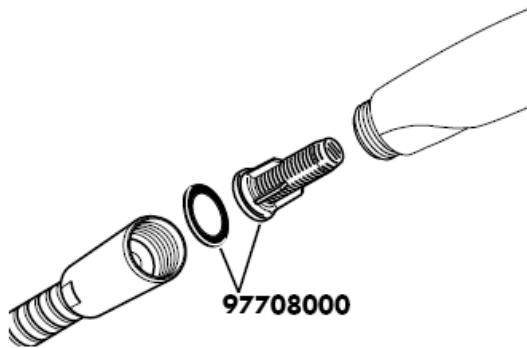

## Croma 100 Vario

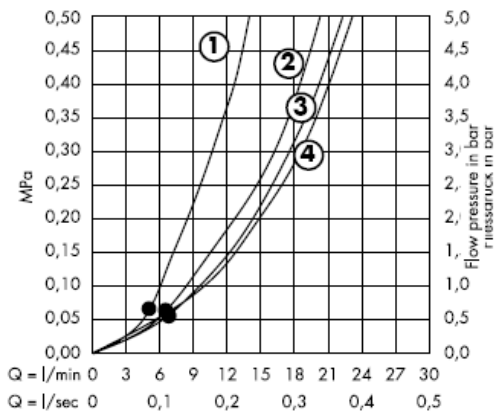

Vanaf • is het functioneren gegarandeerd.

## Croma 100 Multi

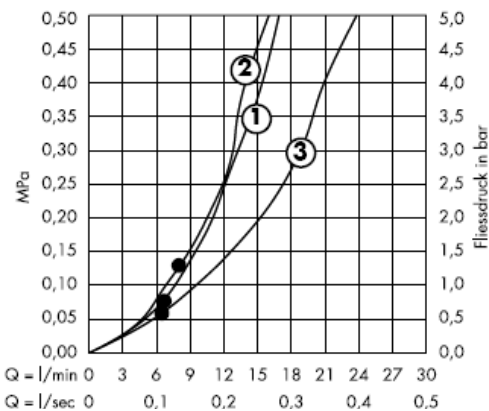

Vanaf • is het functioneren gegarandeerd.

De handdouche is geschikt voor gebruik bij doorstroomtoestellen vanaf 21 kW met een minimale doorstroom van 7 l/min.

## Reinigen

Met Rubit®, de handmatige reinigingsfunctie, kunnen de straalopeningen door het met de hand wegwrijven van kalk, gereinigd worden.

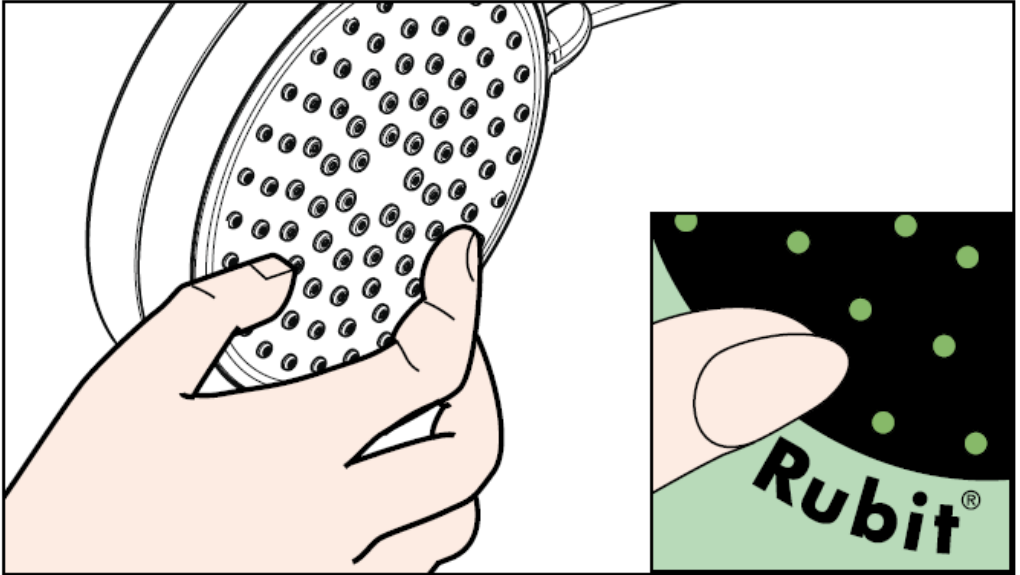

# Reinigen

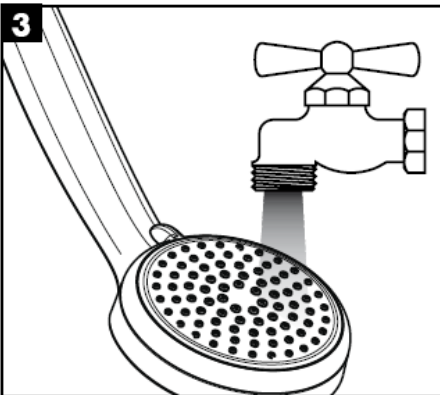
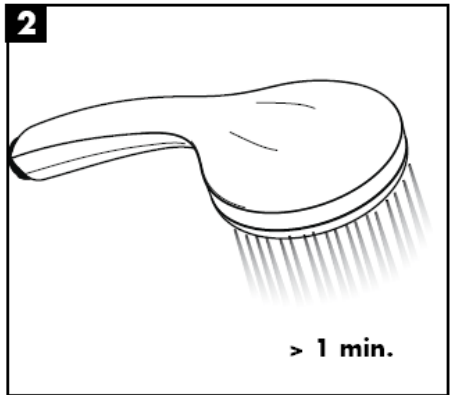
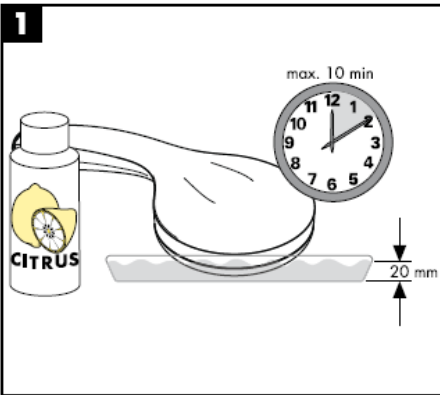
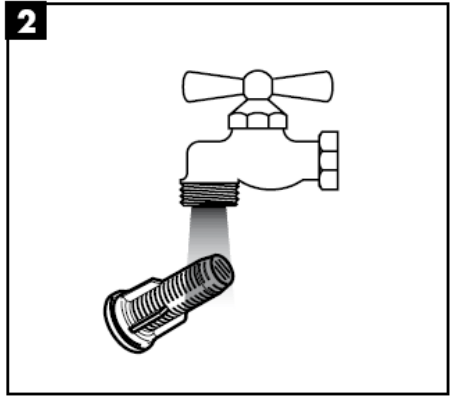
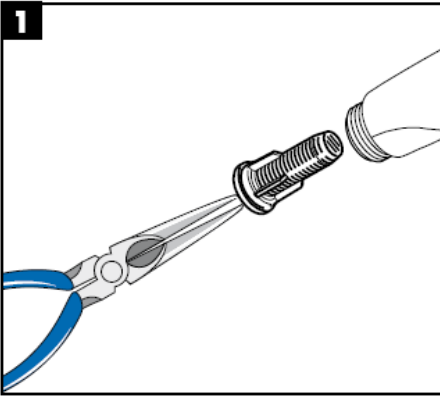

**hansgrohe**





# Monteringsvejledning

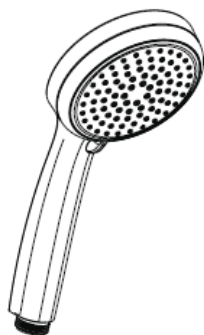

**Cromo 100  
Vario**  
28535000

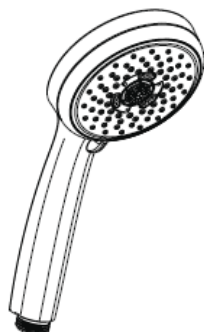

**Cromo 100  
Multi**  
28536000

**hansgrohe**

**Croma 100 Vario**  
28535000

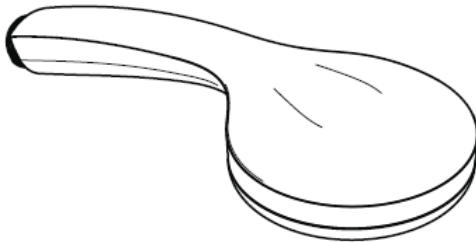

Massage



Shampoo



Normal



Rain

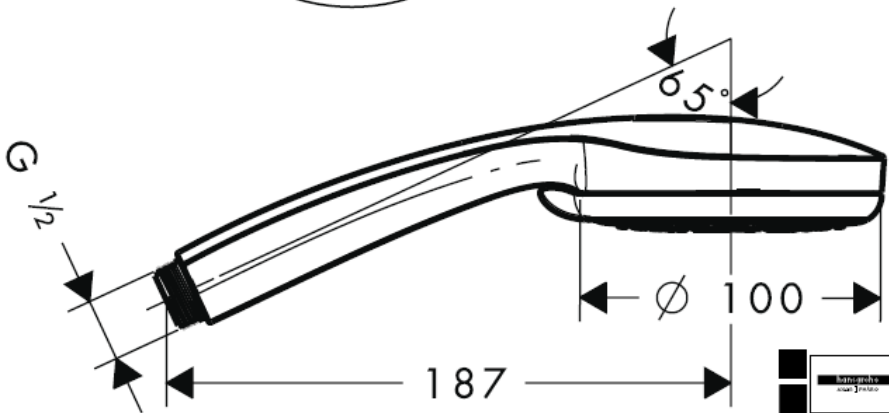

28535000

**Croma 100 Multi**  
28536000

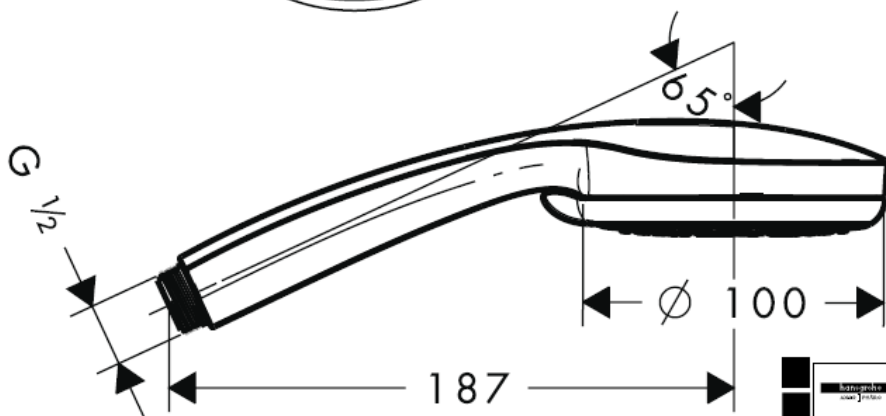
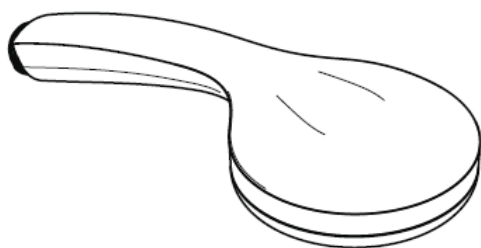
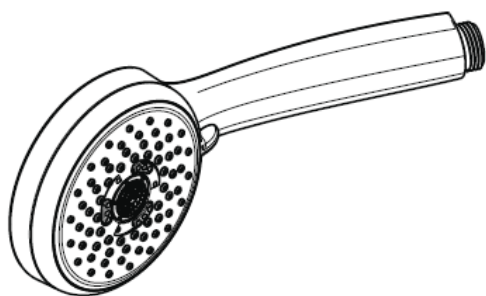

28536000

**Tekniske data**

Driftstryk: max. 0,6 MPa  
 Anbefalet driftstryk: 0,1 – 0,4 MPa  
 (1 MPa = 10 bar = 147 PSI)  
 Varmtvandstemperatur: max. 60° C

	DVGW	P-IX	SVGW	ACS	NF	WRAS	KIWA
28535000		P-IX 18335/ID	X	X			X
28536000		P-IX 18336/ID	X	X			X

**Montering**

Den vedlagte filterindsats (A) skal monteres for at sikre en normal vandgennemstrømning og for at forhindre at der kommer smuds i håndbruseren fra rørsystemet. Ønskes en større vandgennemstrømning skal filterindsatsen (A) erstattes med en smudsfangsi (B). Snavs der er kommet ind i håndbruseren kan skade funktionsdelene i håndbruseren, og Hansgrohes garanti gælder ikke for skader der er opstået på denne måde.

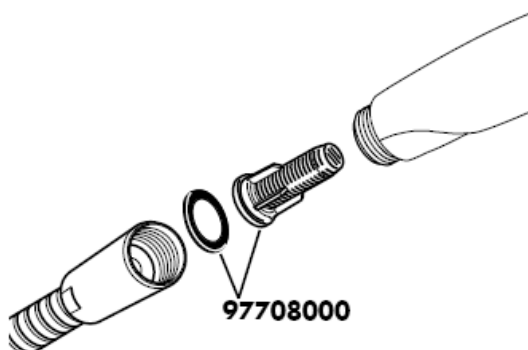

## Croma 100 Vario



Fra • er funktionen anvendelig.

## Croma 100 Multi

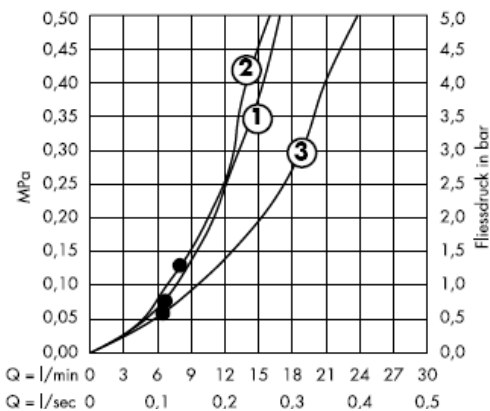

Fra • er funktionen anvendelig.

Håndbruseren er velegnet i forbindelse med gennemstrømningsvandvarmere på min 21 kW samt en gennemstrømningsmængde på min. 7 l/min.

## Rengøring

Med Rubit®, den manuelle rengøringsfunktion kan strålekanalerne let renses for kalk - der skal blot gnubbes!

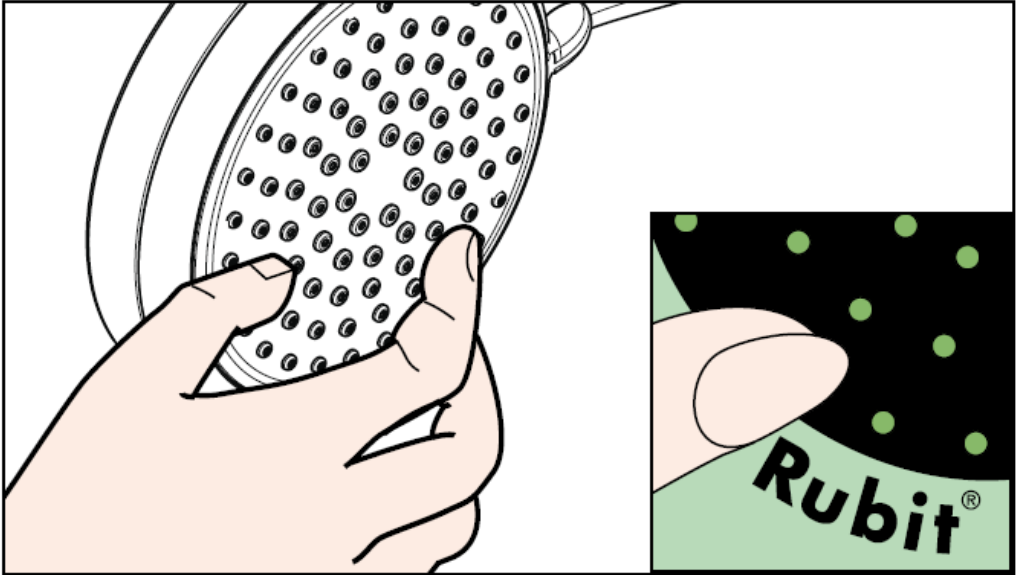

## Rengøring

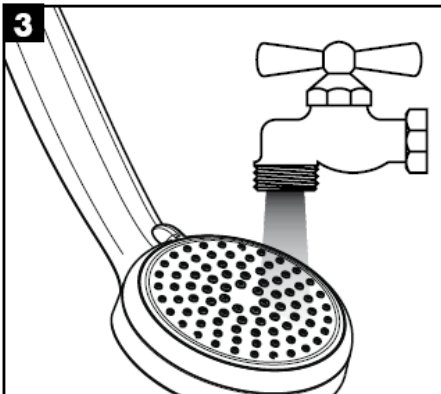
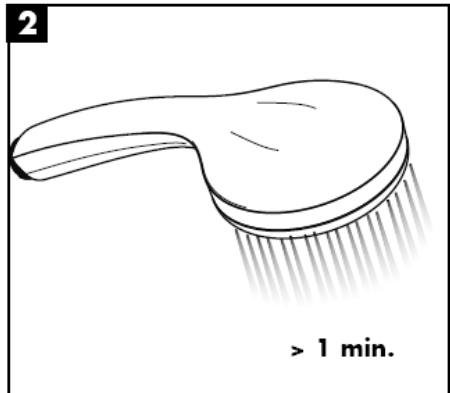
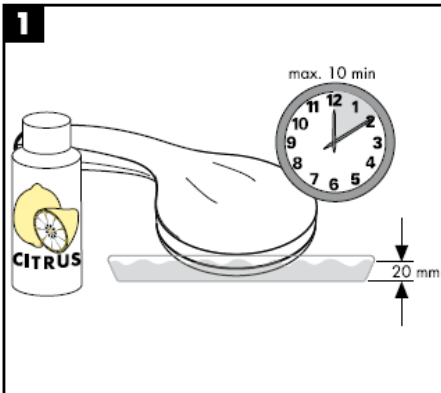
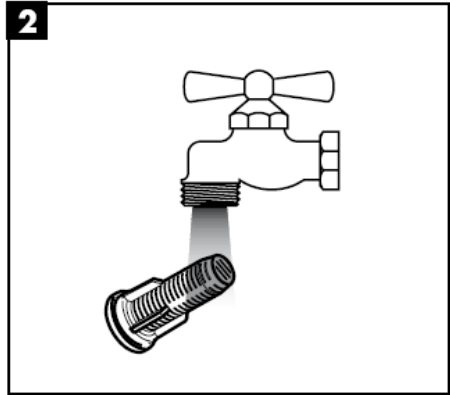
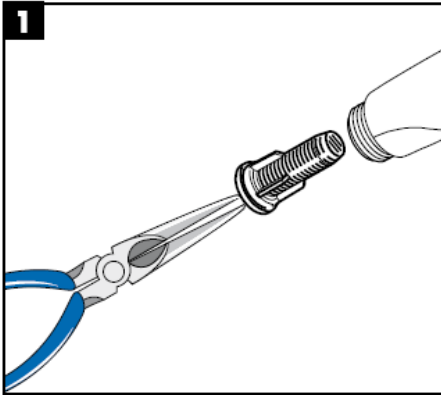

**hansgrohe**





# Manual de Instalación

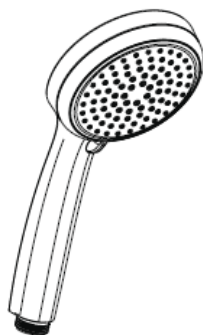

**Cromo 100  
Vario**  
28535000



**Cromo 100  
Multi**  
28536000

**hansgrohe**

**Croma 100 Vario**  
28535000



Massage



Shampoo



Normal



Rain

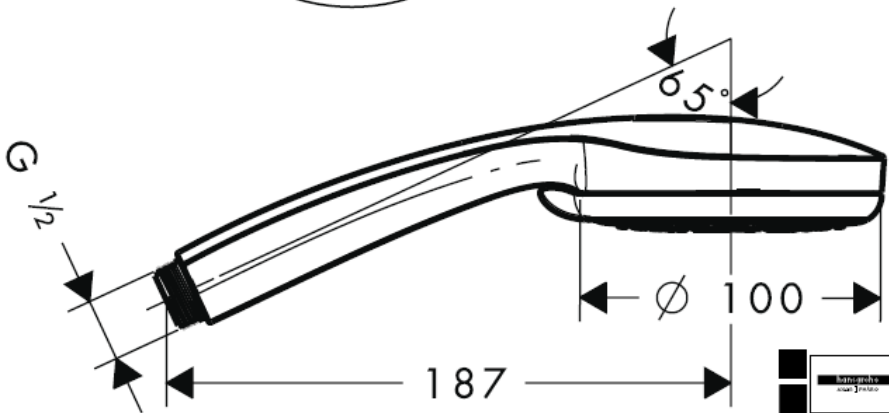

28535000

**Croma 100 Multi**  
28536000



Rain



Mono



Massage

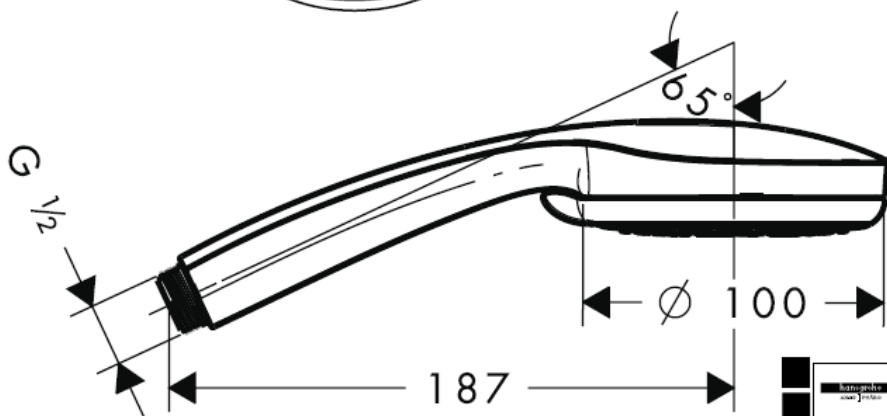

28536000

**Dados Técnicos**

Pressão de funcionamento: max. 0,6 MPa  
 Pressão de func. recomendada: 0,1 – 0,4 MPa  
 (1 MPa = 10 bar = 147 PSI)  
 Temperatura da água quente: max. 60° C

	DVGW	P-IX	SVGW	ACS	NF	WRAS	KIWA
28535000		P-IX 18335/ID	X	X			X
28536000		P-IX 18336/ID	X	X			X

**Montagem**

O filtro de inserção (A) deve ser utilizado para assegurar um caudal standart e para proteger o chuveiro de mão de areias e resíduos provenientes da tubagem. Se quiser um caudal maior, deve usar o filtro de junção (B) em vez do filtro de inserção (A).

Resíduos e areias podem danificar componentes ou provocar o mau funcionamento do chuveiro; as avarias assim provocadas anulam a responsabilidade e garantia Hansgrohe.

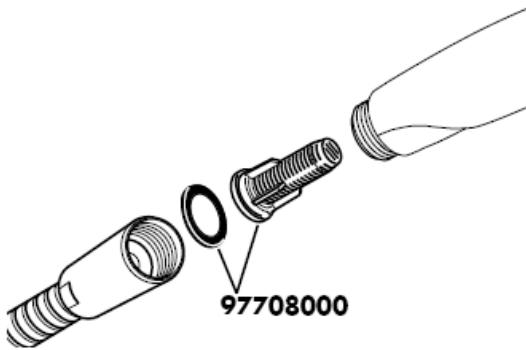

## Croma 100 Vario



- A partir deste ponto inicia-se o funcionamento correcto.

## Croma 100 Multi

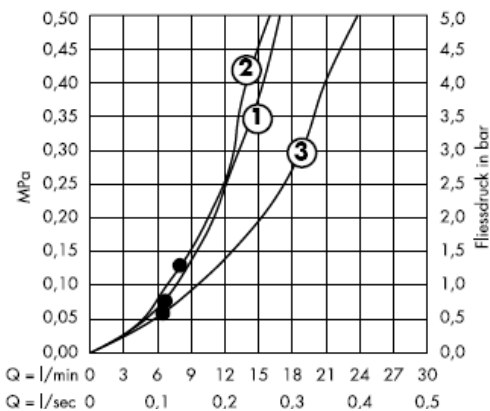

- A partir deste ponto inicia-se o funcionamento correcto.

O chuveiro de mão é compatível com esquentadores instantâneos de 21 kW e um caudal mínimo de 7 l/minuto.

O sistema de limpeza Rubit® requer apenas uma ligeira passagem com a mão para remover os depósitos de calcário do emulsor.

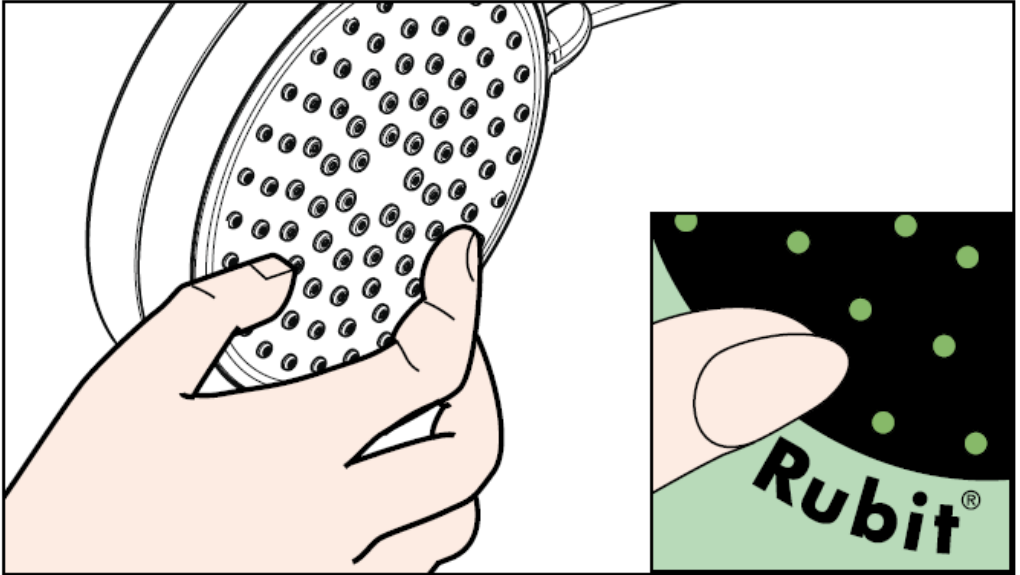

## Limpeza

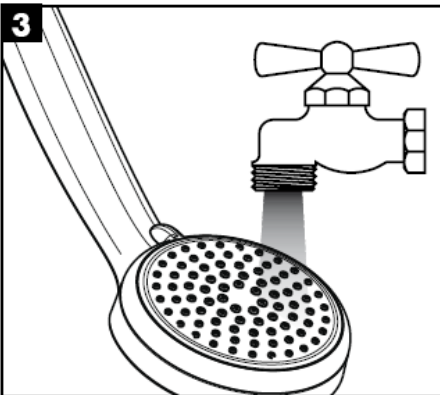
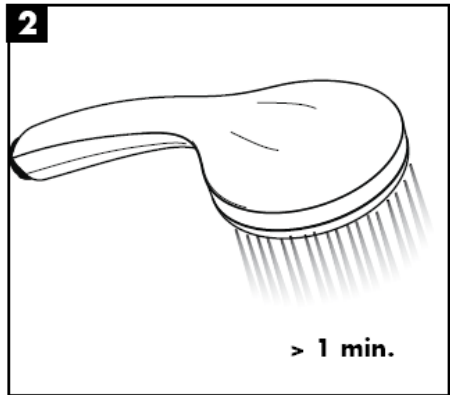
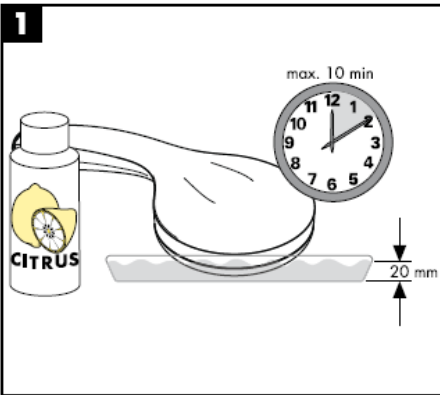
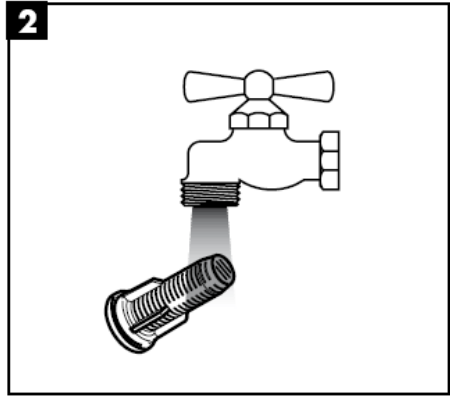
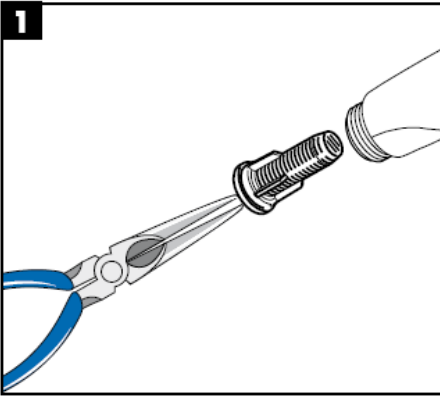

**hansgrohe**





# Instrukcja montażu

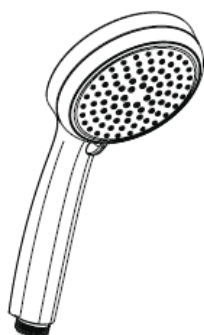

**Cromo 100  
Vario**  
28535000

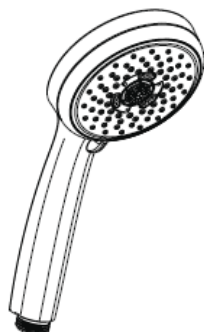

**Cromo 100  
Multi**  
28536000

**hansgrohe**

**Croma 100 Vario**  
28535000

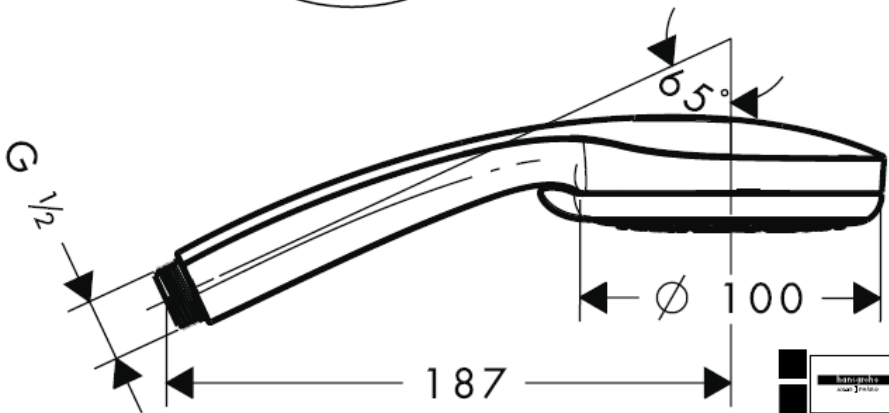
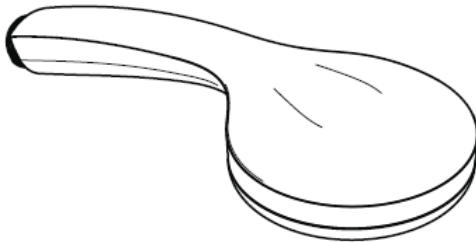

28535000

**Croma 100 Multi**  
28536000

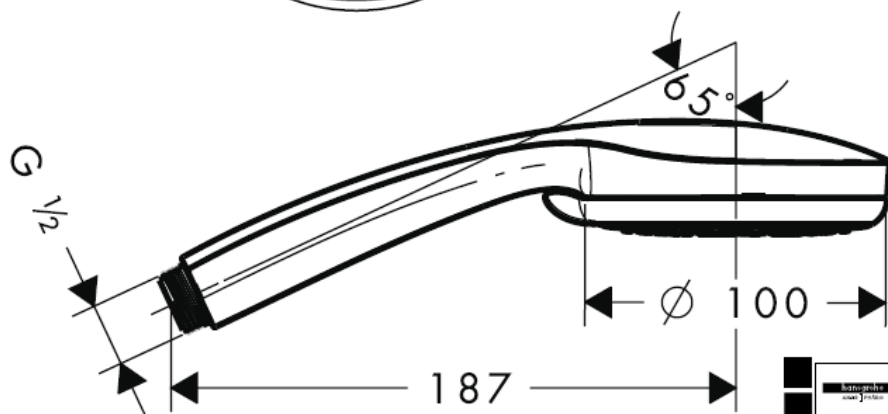
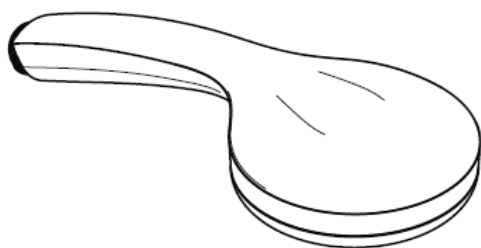

28536000

**Dane techniczne**

Ciśnienie robocze: max. 0,6 MPa  
 Zalecane ciśnienie robocze: 0,1 – 0,4 MPa  
 (1 MPa = 10 bary = 147 PSI)  
 Temperatura wody gorącej: max. 60° C

	DVGW	P-IX	SVGW	ACS	NF	WRAS	KIWA
28535000		P-IX 18335/ID	X	X			X
28536000		P-IX 18336/ID	X	X			X

**Montaż**

Należy zamontować znajdującą się w opakowaniu wkładkę filtra (A), aby zapewnić przepisowy przepływ przez prysznic ręczny i zapobiec przedostawaniu się zanieczyszczeń z instalacji sieciowej. Jeżeli pożądanym jest większy przepływ wody, wówczas należy zamiast wkładki filtra (A) użyć uszczelki z sitkiem (B). Przedostające się zanieczyszczenia mogą mieć negatywny wpływ na działanie i/lub prowadzić do usterek w działaniu elementów prysznica ręcznego. Za powstałe z tego tytułu szkody firma Hansgrohe nie ponosi odpowiedzialności.

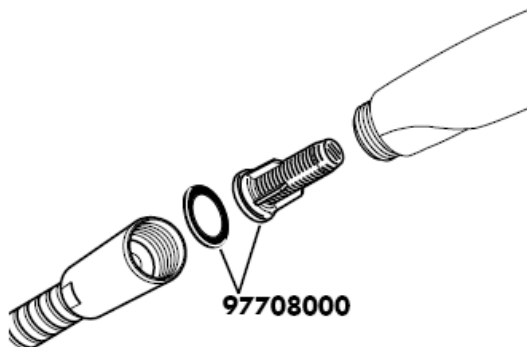

## Croma 100 Vario



Od • możliwe jest funkcjonowanie.

## Croma 100 Multi

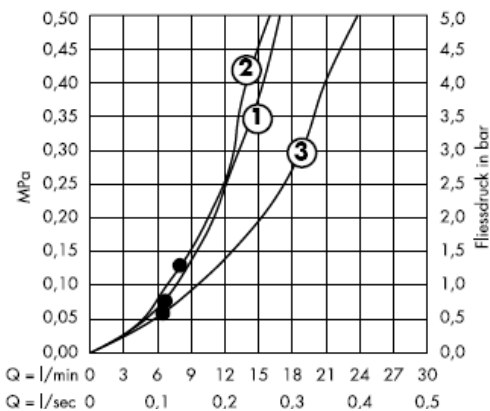

Od • możliwe jest funkcjonowanie.

Prysznic ręczny jest przystosowany do przepływowych podgrzewaczy wody o mocy powyżej 21 kW i przepływie minimalnym 7 l/min.

## Czyszczenie

Funkcja Rubit® wymaga jedynie delikatnego potarcia dłonią, aby usunąć ewentualne osady kamienia wapiennego.

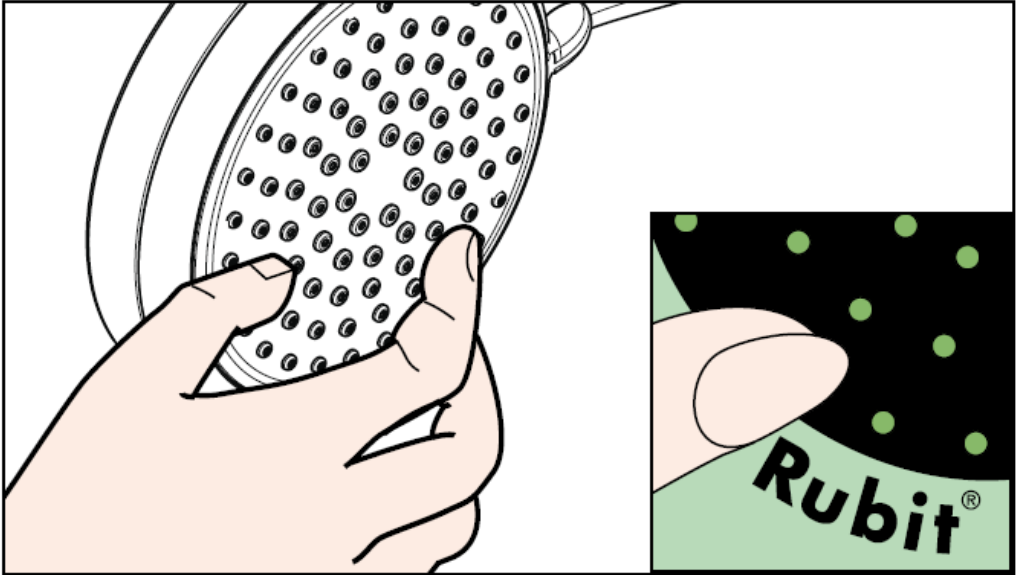

## Czyszczenie

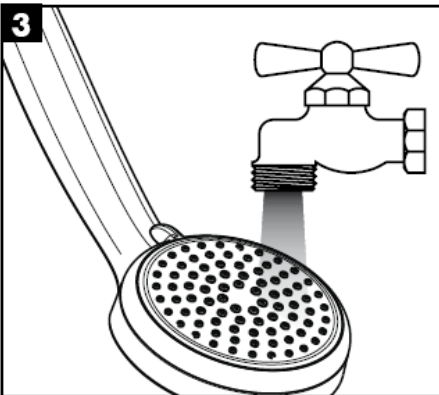
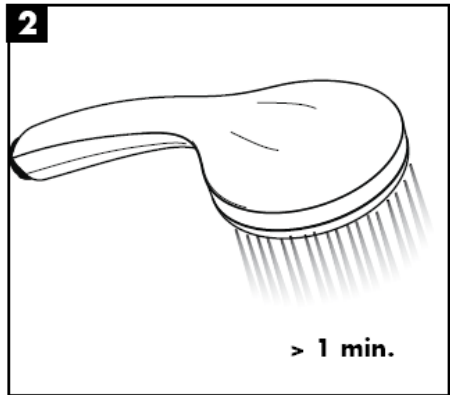
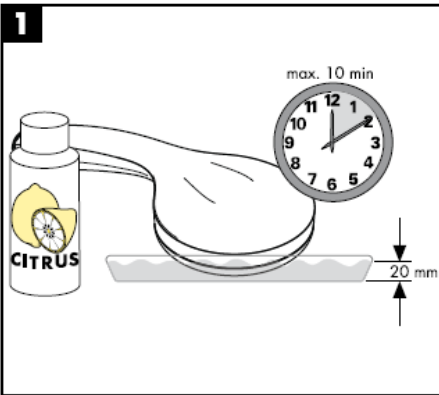
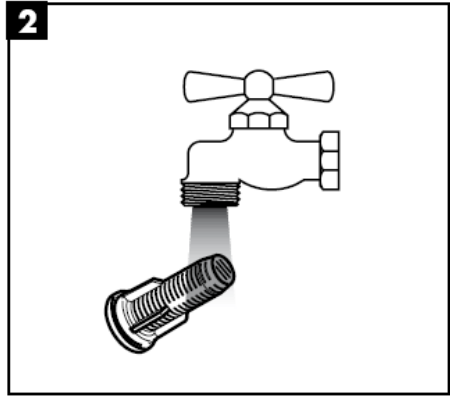
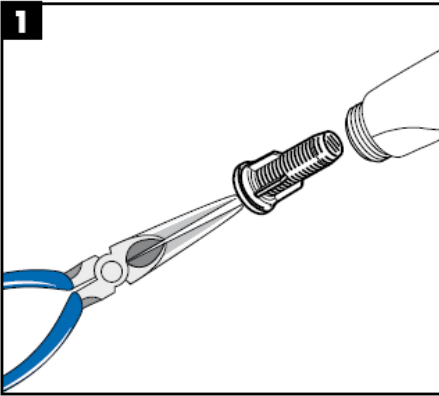

**hansgrohe**





# Montážní návod

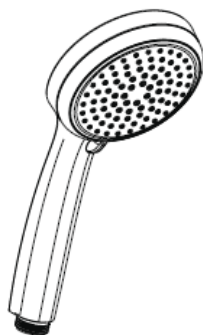

**Croma 100  
Vario**  
28535000

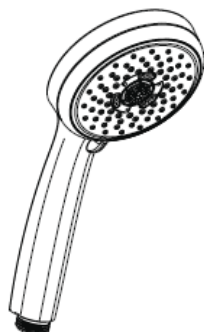

**Croma 100  
Multi**  
28536000

**hansgrohe**

**Croma 100 Vario**  
28535000



Massage



Shampoo



Normal



Rain

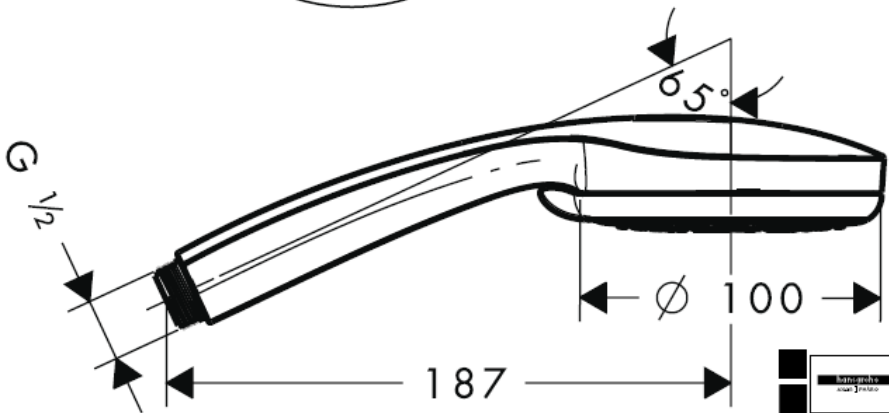

28535000

**Croma 100 Multi**  
28536000



Rain



Mono



Massage

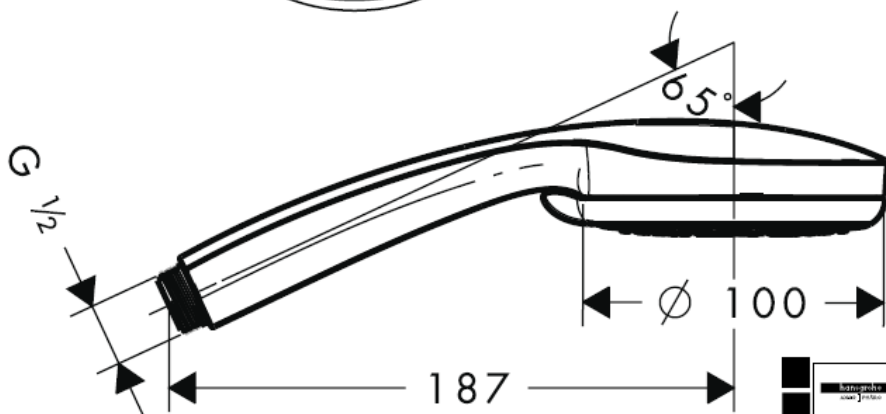

28536000

### Technické údaje

Provozní tlak: max. 0,6 MPa  
 Doporučený provozní tlak: 0,1 – 0,4 MPa  
 (1 MPa = 10 barů = 147 PSI)  
 Teplota horké vody: max. 60° C

	DVGW	P-IX	SVGW	ACS	NF	WRAS	KIWA
28535000		P-IX 18335/ID	X	X			X
28536000		P-IX 18336/ID	X	X			X

### Montáž

Příbalená filtrační vložka (A) se musí zabudovat, aby zajistila jmenovitý průtok ruční sprchou a zabránila přístupu nečistot vyplavovaných z potrubí.  
 Pokud se požaduje vyšší průtok, musí se vsadit místo filtrační vložky (A) těsnění se sítkem (B). Vyplavené nečistoty mohou ovlivnit funkčnost a nebo také vést k poškození funkčních dílů ruční sprchy. Na tyto škody se záruka firmy Hansgrohe nevztahuje.

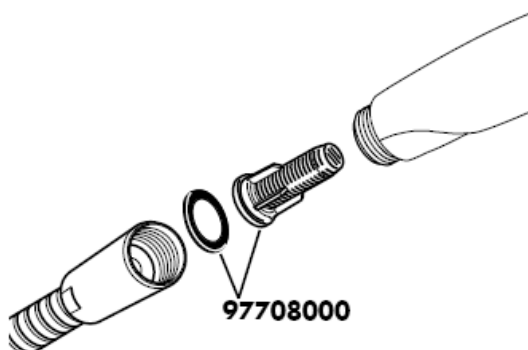

## Croma 100 Vario



Od • je zaručená funkce

## Croma 100 Multi

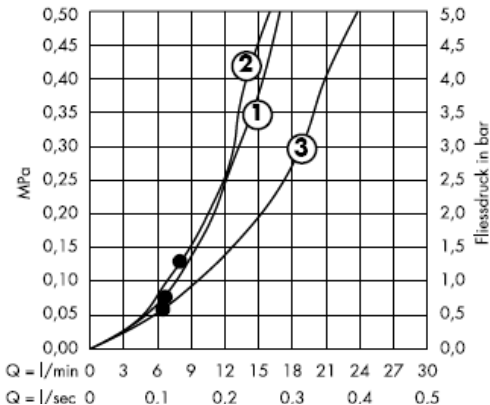

Od • je zaručená funkce

Ruční sprcha je vhodná k použití s průtokovým ohřívačem výkonu od 21 kW a průtoku 7 l/min.

## Čištění

S ruční čisticí funkcí Rubit® stačí jednoduché odstranění vodního kamene prsty z trysek kotouče tvarujícího proud vody.

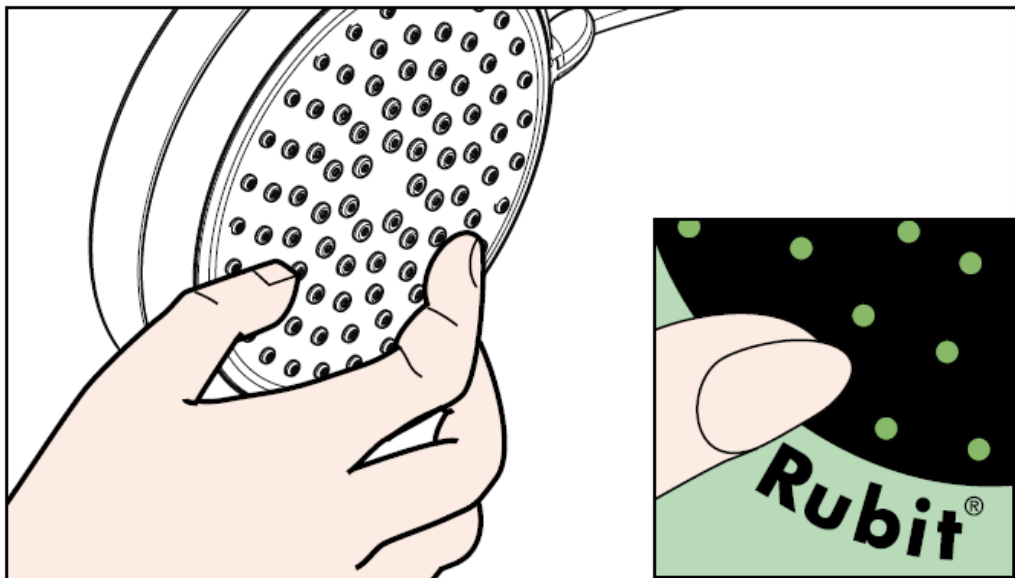

## Čištění

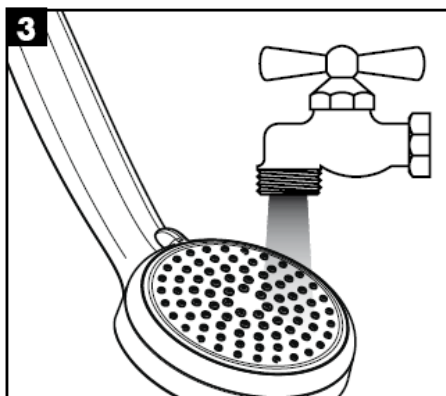
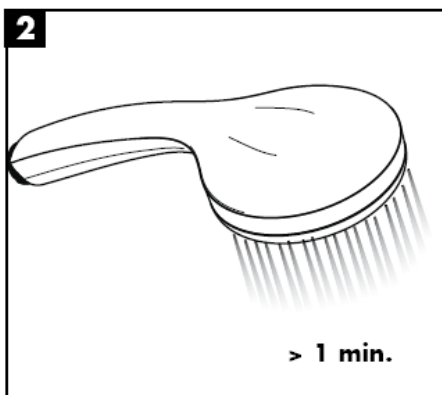
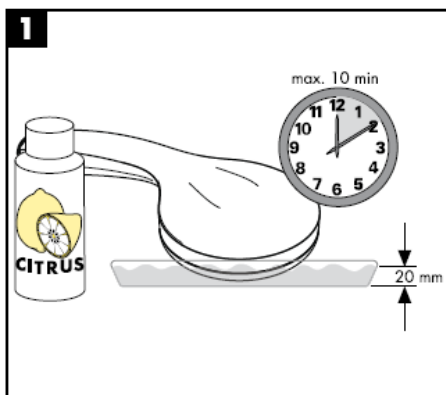
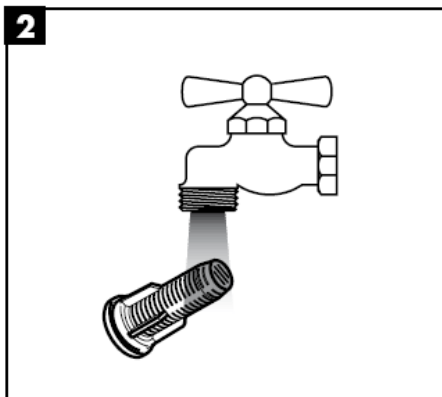
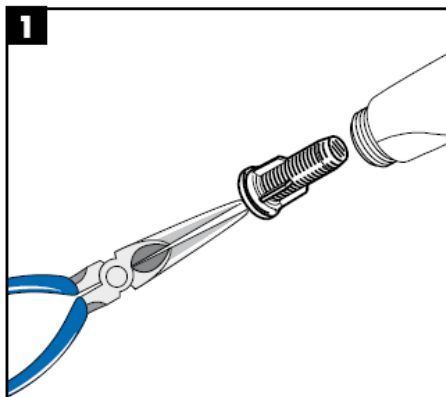

**hansgrohe**





# Montážny návod

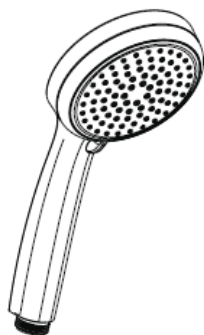

**Croma 100  
Vario**  
28535000



**Croma 100  
Multi**  
28536000

**hansgrohe**

**Croma 100 Vario**  
28535000



Massage



Shampoo



Normal



Rain

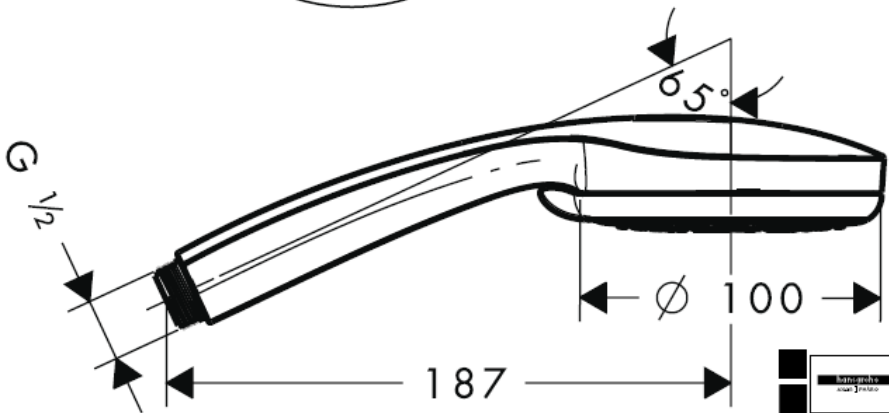

28535000

**Croma 100 Multi**  
28536000



Rain



Mono



Massage

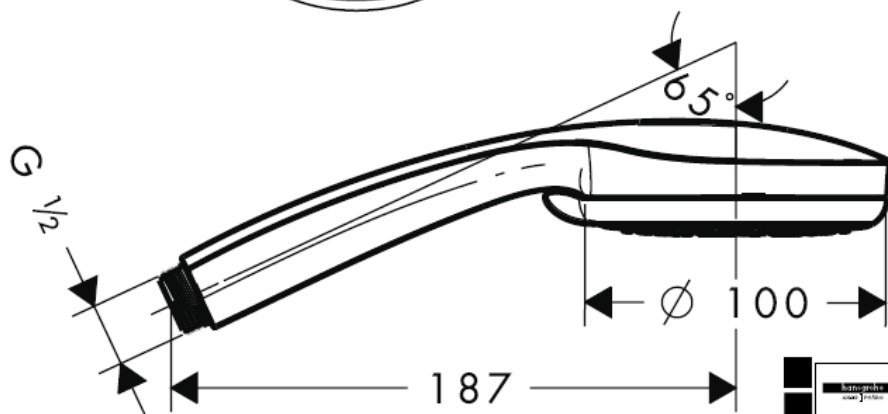
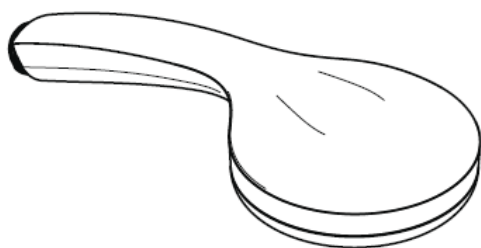

28536000

**Technické údaje**

Prevádzkový tlak: max. 0,6 MPa  
 Doporučený prevádzkový tlak: 0,1 – 0,4 MPa  
 (1 MPa = 10 barov = 147 PSI)  
 Teplota teplej vody: max. 60° C

	DVGW	P-IX	SVGW	ACS	NF	WRAS	KIWA
28535000		P-IX 18335/ID	X	X			X
28536000		P-IX 18336/ID	X	X			X

**Montáž**

Pribalená filtračná vložka (A) sa musí zabudovať, aby zaistila menovitý prietok ručnou sprchou a zabránila prístupu nečistôt vyplavovaných z potrubia.

Pokiaľ sa požaduje vyšší prietok, musí sa vsadiť namiesto filtračnej vložky (A) tesnenie so sitkom (B). Vyplavené nečistoty môžu ovplyvniť funkčnosť alebo môžu viesť aj k poškodeniu funkčných dielov ručnej sprchy. Na tieto škody sa záruka firmy Hansgrohe nevzťahuje.

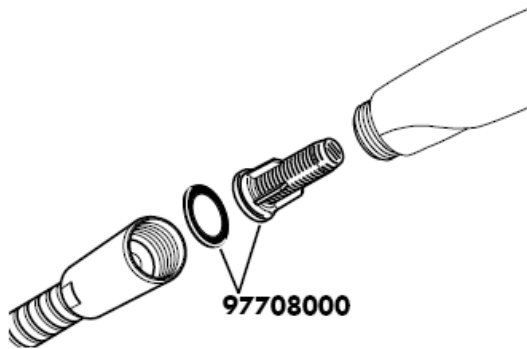

## Croma 100 Vario



Od • je zaručená funkcia.

## Croma 100 Multi

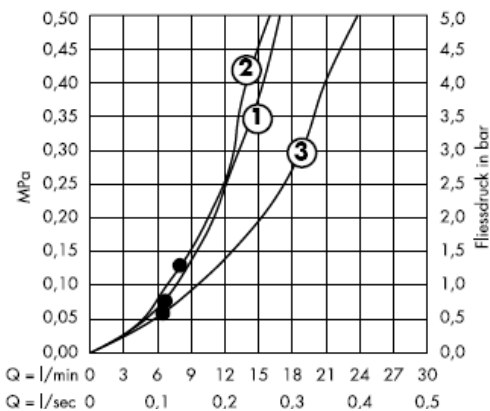

Od • je zaručená funkcia.

Ručná sprcha je vhodná k použitiu s prietokovým ohrievačom s výkonom od 21 kW a prietoku 7 l/min.

Čistiaca funkcia Rubit, stačí na jednoduché odstránenie vodného kameňa prstami z trysiek kotúča tvarujúceho prúd vody.

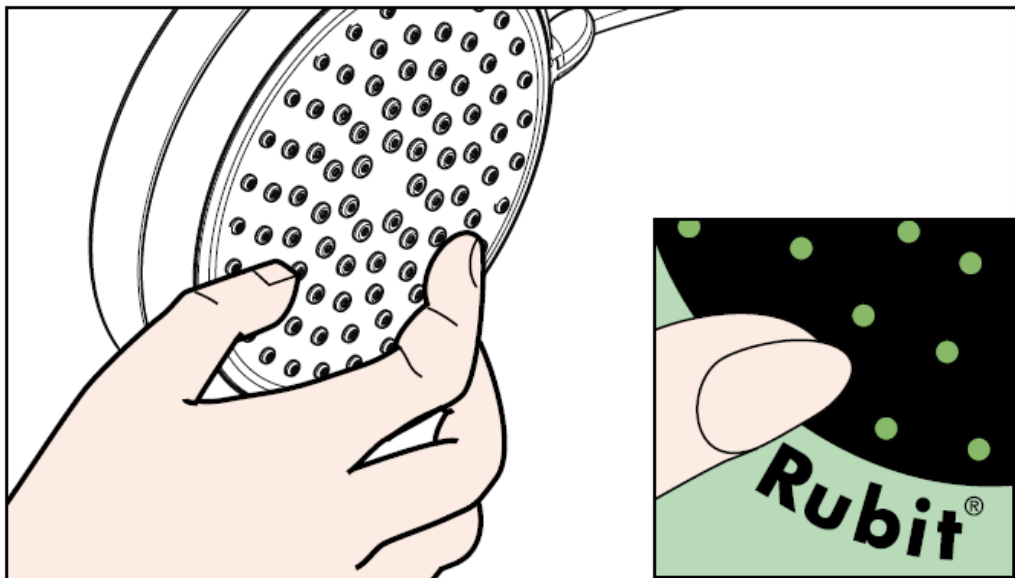

## Čištění

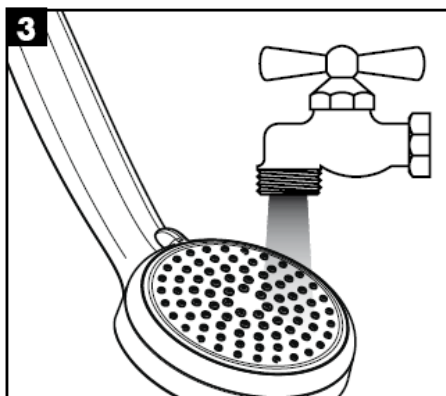
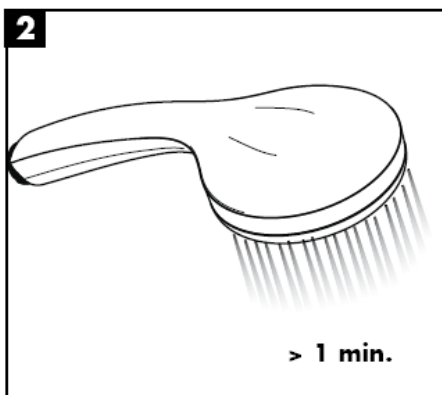
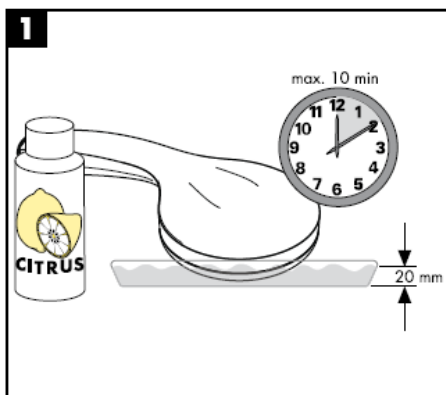
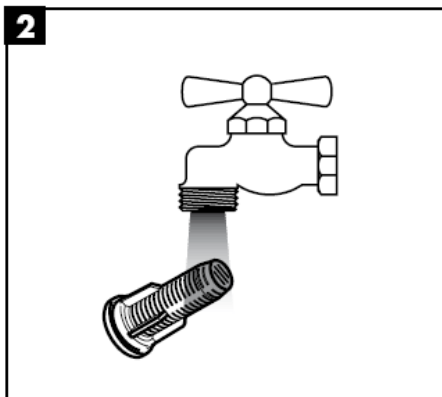
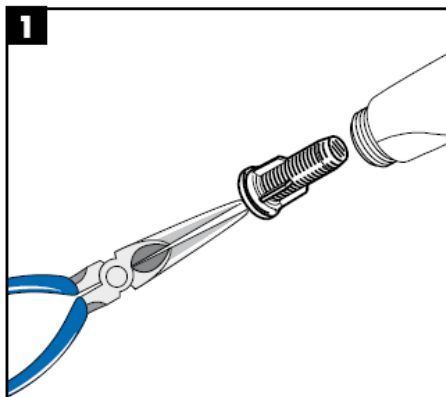

**hansgrohe**





# 组装说明

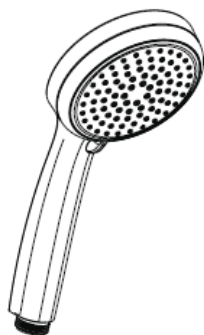

**Cromo 100  
Vario**  
28535000

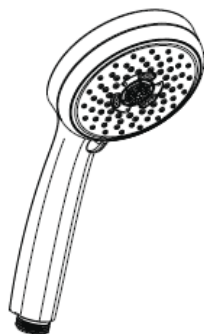

**Cromo 100  
Multi**  
28536000

**hansgrohe**

**Croma 100 Vario**  
28535000

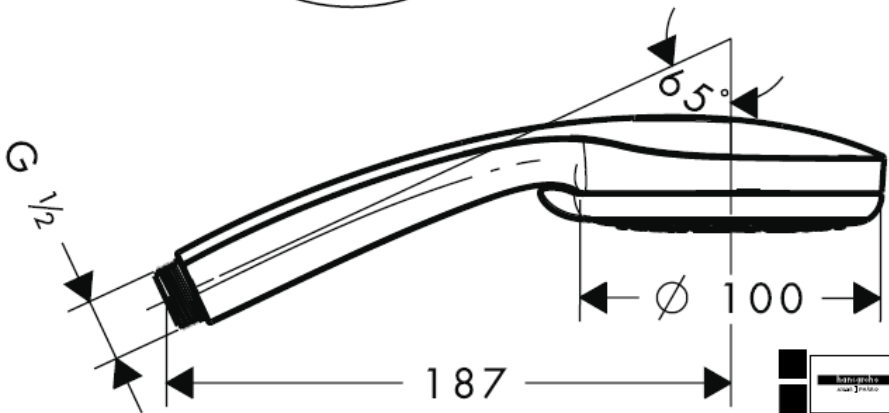
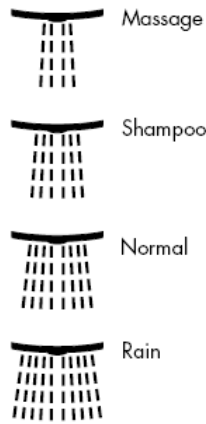
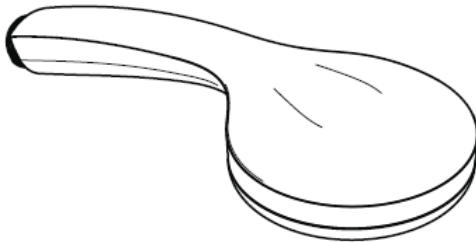

28535000

**Croma 100 Multi**  
28536000



Rain



Mono



Massage

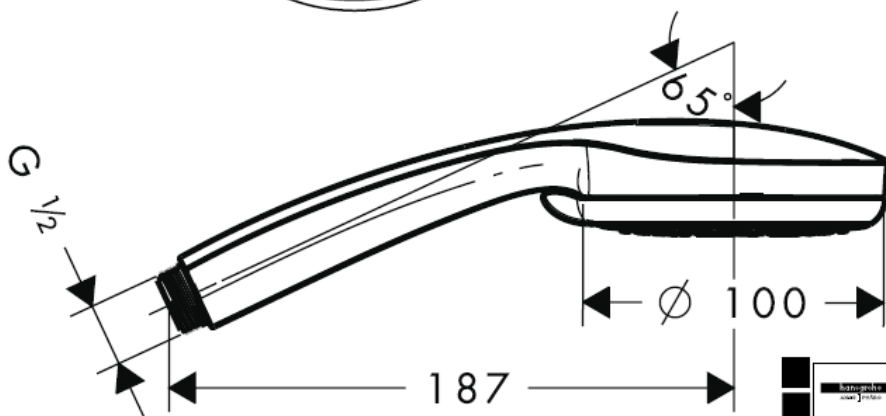

28536000

## 技术参数

工作压强:	max. 0,6 MPa
推荐工作压强: (1 MPa = 10 巴 = 147 PSI)	0,1 – 0,4 MPa
热水温度:	max. 60° C

	DVGW	P-IX	SVGW	ACS	NF	WRAS	KIWA
28535000		P-IX 18335/ID	X	X			X
28536000		P-IX 18336/ID	X	X			X

## 安装

为了防止管道中的脏东西冲入花洒内，与手持花洒包装在一起的滤柱（A）必须安装。如果想要更大的出水量，可用滤网（B）代替滤柱（A）。

这些脏东西会影响手持花洒的功能或损坏手持花洒的功能部件，由此引起的损失汉斯格雅公司概不负责。

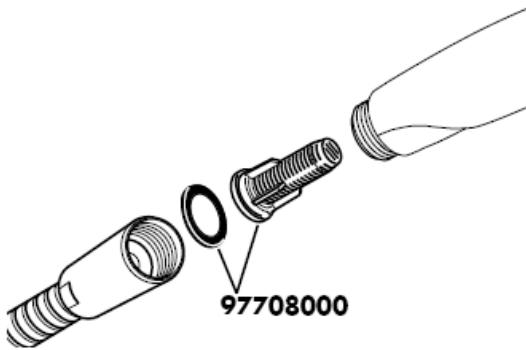

## Croma 100 Vario

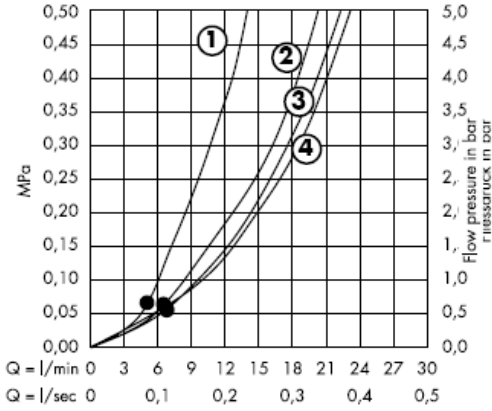

从•开始，正常功能得以保证。

## Croma 100 Multi

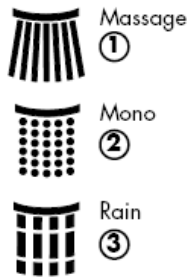
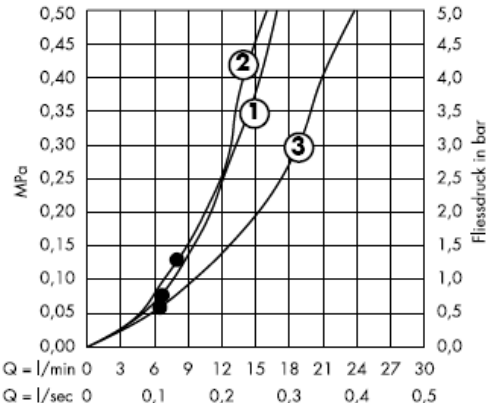

从•开始，正常功能得以保证。

手提花洒适合热输出21 kW、最低流量7升/分钟的连续流热水器。

## 清洗

有了Rubit®，手工清洁功能，要去掉喷头上的水垢，只需简单地搓除即可。

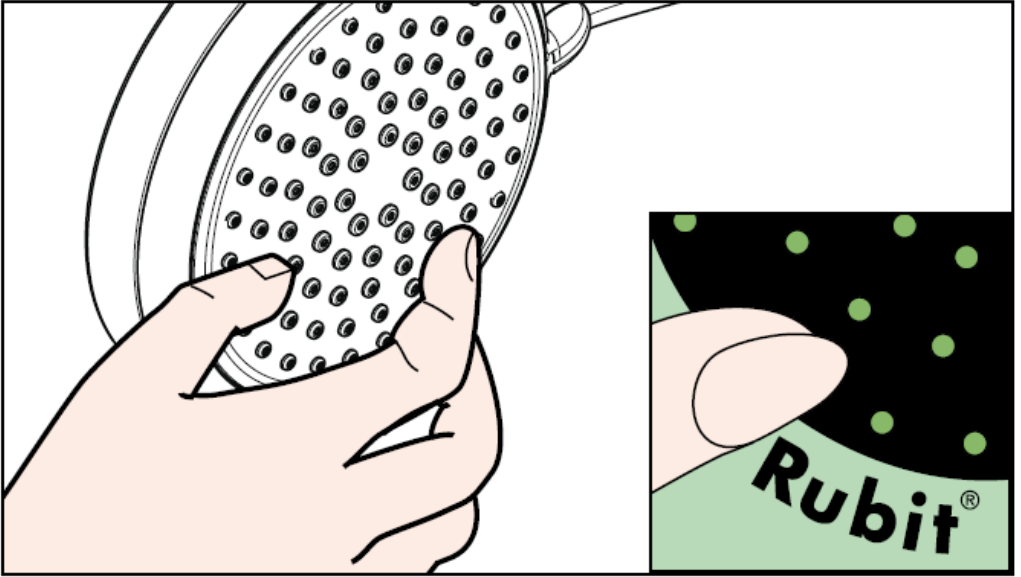

清洗

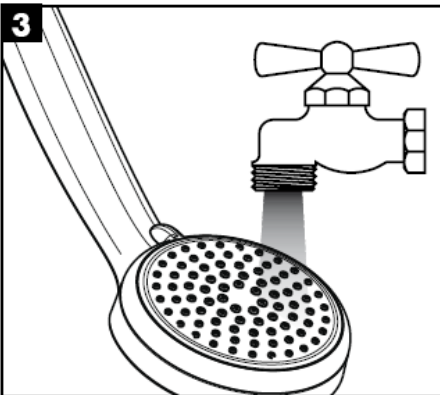
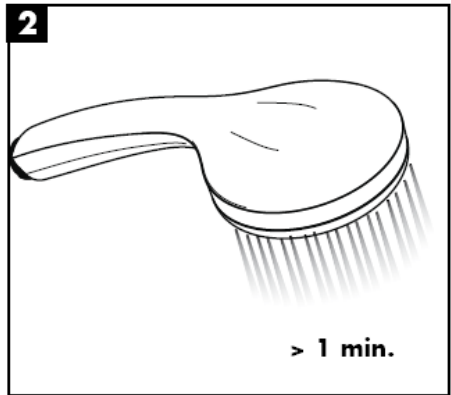
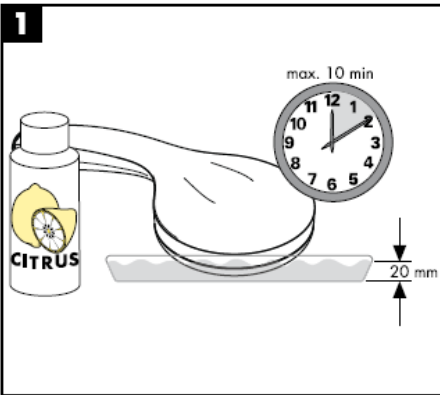
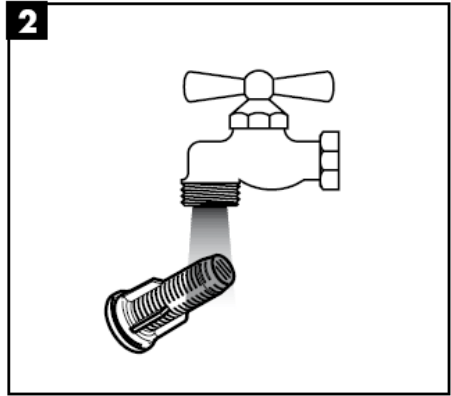
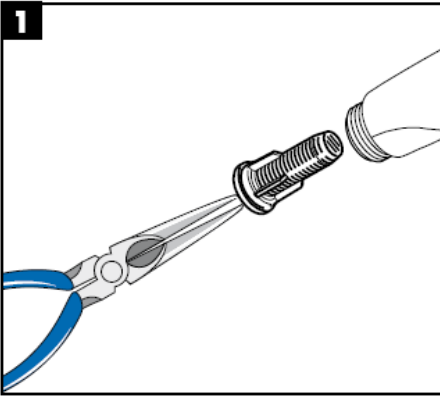

**hansgrohe**





# Инструкция по монтажу

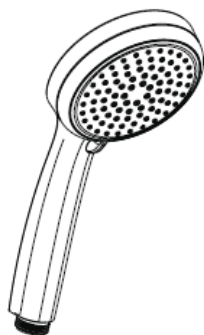

**Cromo 100  
Vario**  
28535000



**Cromo 100  
Multi**  
28536000

**hansgrohe**

**Croma 100 Vario**  
28535000



Massage



Shampoo



Normal



Rain

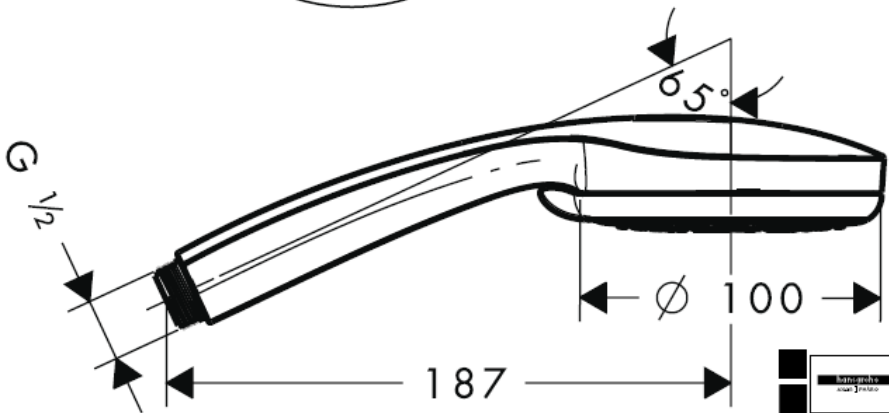

28535000

**Croma 100 Multi**  
28536000

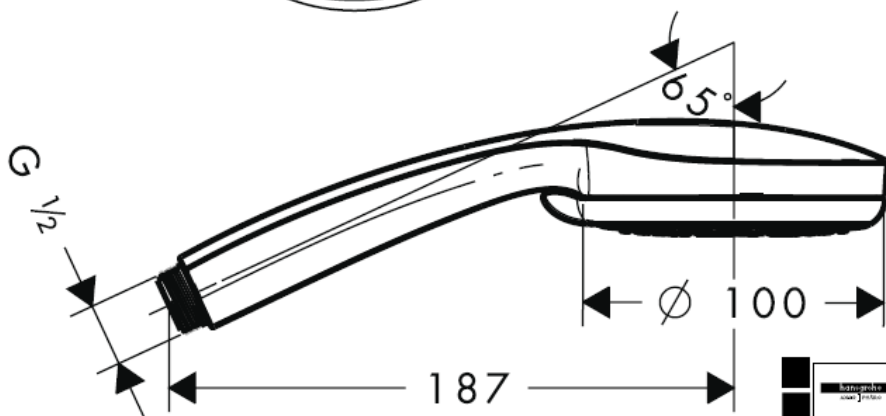
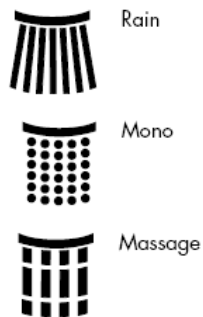

28536000

**Технические данные**

Рабочее давление: max. 0,6 МПа  
 Рекомендуемое рабочее давление: 0,1 – 0,4 МПа  
 (1 МПа = 10 бар = 147 PSI)  
 Температура горячей воды: max. 60° C

	DVGW	P-IX	SVGW	ACS	NF	WRAS	KIWA
28535000		P-IX 18335/ID	X	X			X
28536000		P-IX 18336/ID	X	X			X

**Монтаж**

Предустановленный фильтр (A) предназначен для обеспечения стандартного расхода воды и защиты внутренней части лейки ручного душа от содержащихся в водопроводной воде загрязнений. Если Вы желаете повысить расход воды, Вам необходимо заменить предустановленный фильтр (A) на фильтр-сеточку (B).

Содержащиеся в воде загрязнения могут попасть внутрь лейки привести к повреждениям/поломке внутреннего механизма лейки.

В этом случае покупатель теряет право на гарантию.

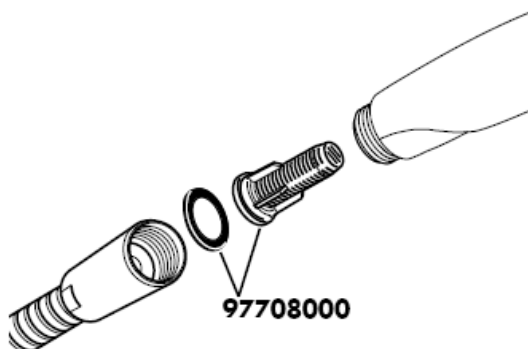

## Croma 100 Vario

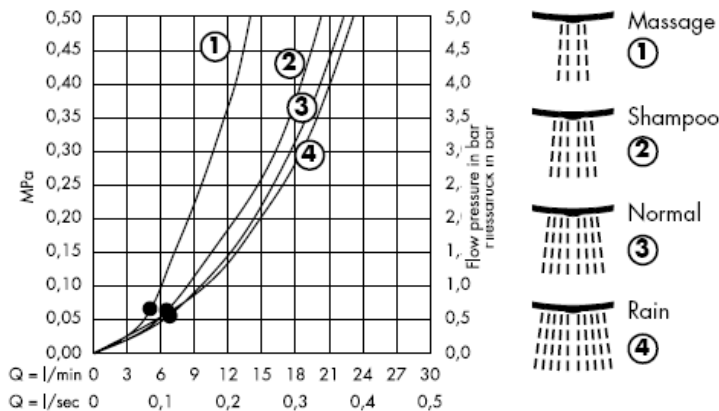

Гарантированное функционирование при показателях свыше •.

## Croma 100 Multi

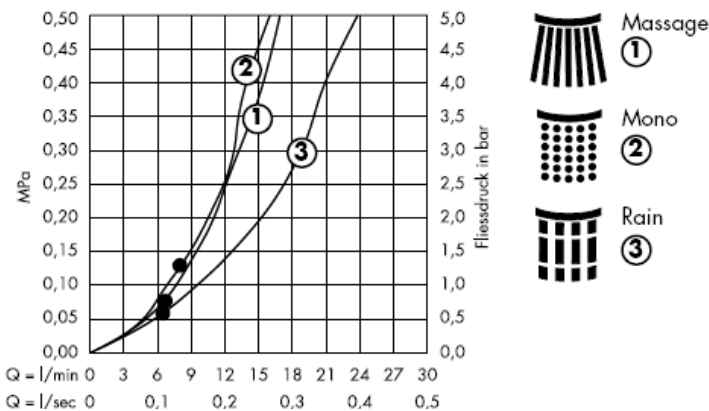

Гарантированное функционирование при показателях свыше •.

Ручной душ может использоваться с проточными водонагревателями мощностью от 21кВт и напором воды не менее 7 л/мин.

система Rubit® позволяет удалять известковые отложения, достаточно провести по эластичной поверхности аэратора пальцем, как известковые отложения будут удалены.

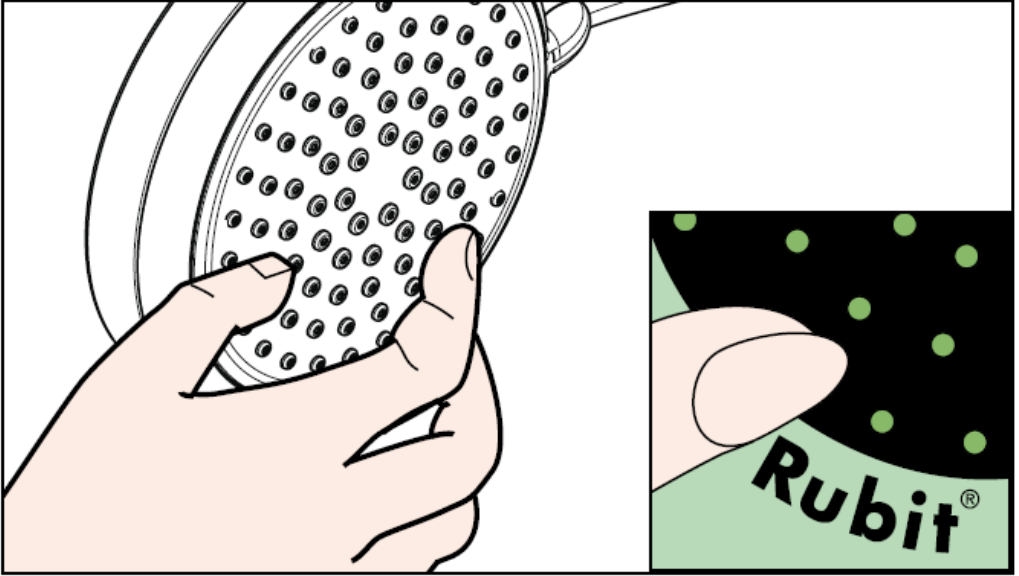

## Очистка

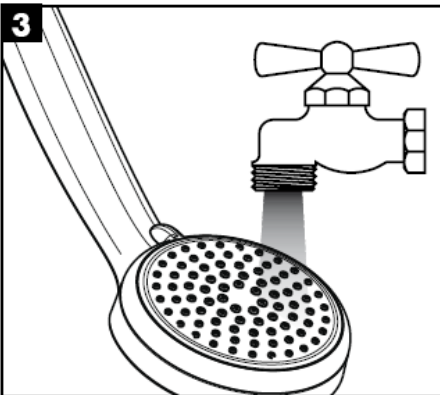
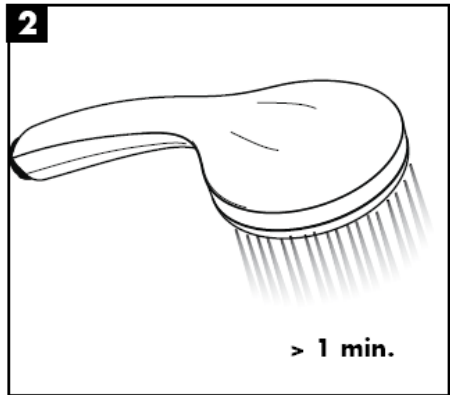
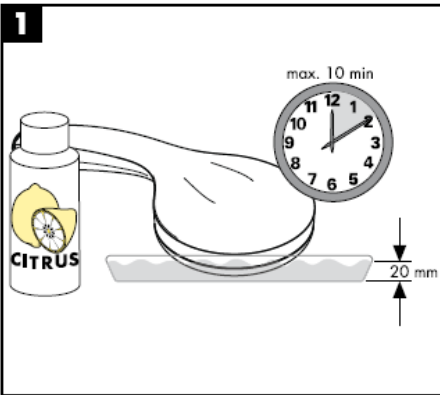
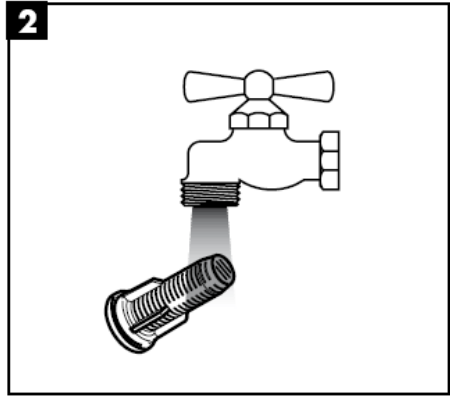
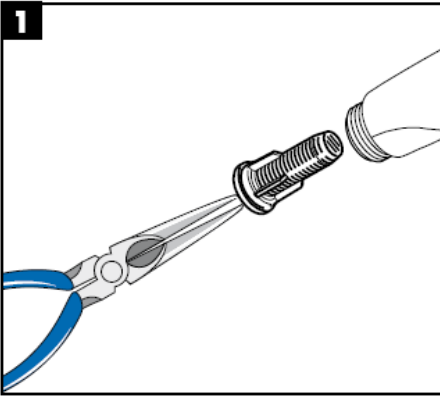

**hansgrohe**





# Szerelési útmutató

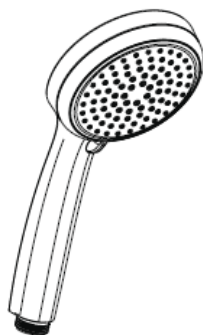

**Croma 100  
Vario**  
28535000



**Croma 100  
Multi**  
28536000

**hansgrohe**

**Croma 100 Vario**  
28535000

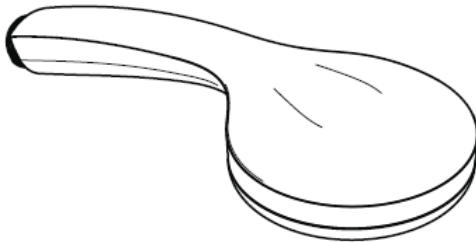

Massage



Shampoo



Normal



Rain

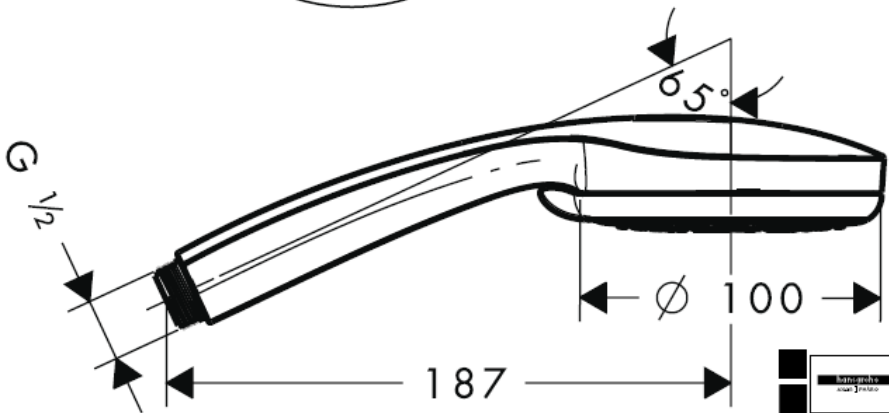

28535000

**Croma 100 Multi**  
28536000



Rain



Mono



Massage

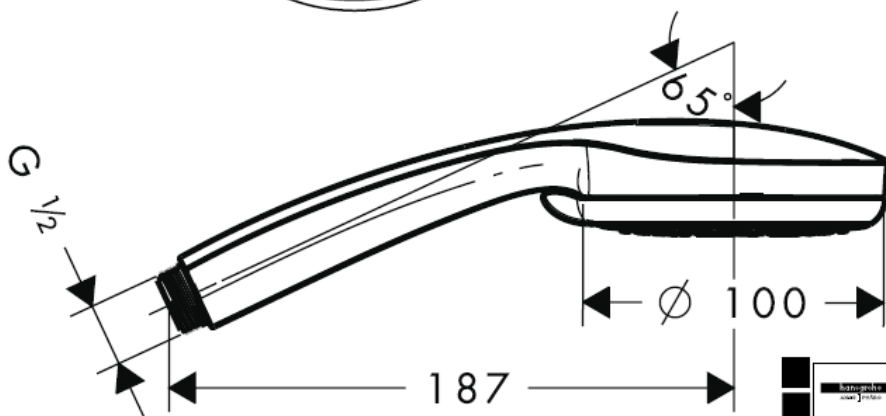

28536000

**Műszaki adatok**

Üzemi nyomás: max. 0,6 MPa  
 Ajánlott üzemi nyomás: 0,1 – 0,4 MPa  
 (1 MPa = 10 bar = 147 PSI)  
 Forróvíz hőmérséklet: max. 60° C

	DVGW	P-IX	SVGW	ACS	NF	WRAS	KIWA
28535000		P-IX 18335/ID	X	X			X
28536000		P-IX 18336/ID	X	X			X

**Szerelés**

A mellékelt szűrőbetétet (A) be kell szerelni, hogy elérjük a kézizuhany norma szerinti átfolyását, valamint, hogy elkerüljük a vezetékes hálózathoz tartozó szennyeződések zuhanyba való bekerülését. Amennyiben nagyobb átfolyási vízmennyiséget szeretnénk elérni, a szűrőbetét (A) helyett használjuk a szűrőtömítést (B). A vezetékes hálózathoz tartozó szennyeződések gátolhatják a termék működését, és/vagy megrongálhatják a zuhany működő alkatrészeit. Az ebből adódó károkért a Hansgrohe nem felel.

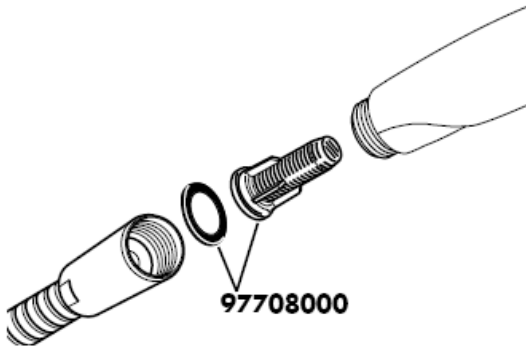

## Croma 100 Vario

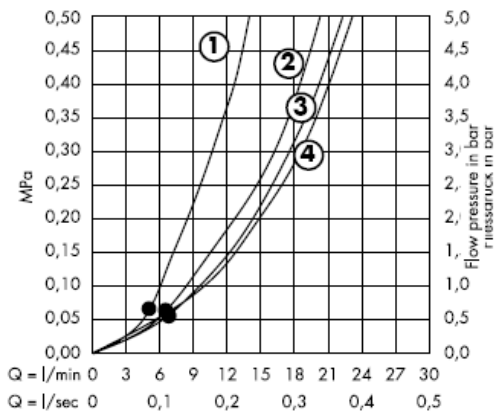

A • -től működik az adott funkció.

## Croma 100 Multi

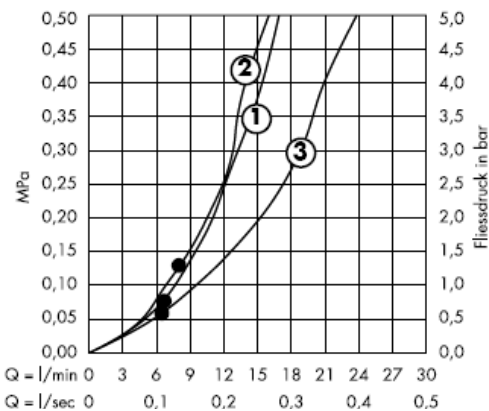

A • -től működik az adott funkció.

A kézizuhany átfolyós vízmelegítővel való használatra 21 kW-os teljesítménytől és 7l/perc minimális átfolyástól alkalmas.

A Rubit® manuális tisztítófunkciónak köszönhetően a vízsugárnyílások egyszerű ledörzsöléssel megtisztíthatóak a vízkőtől.

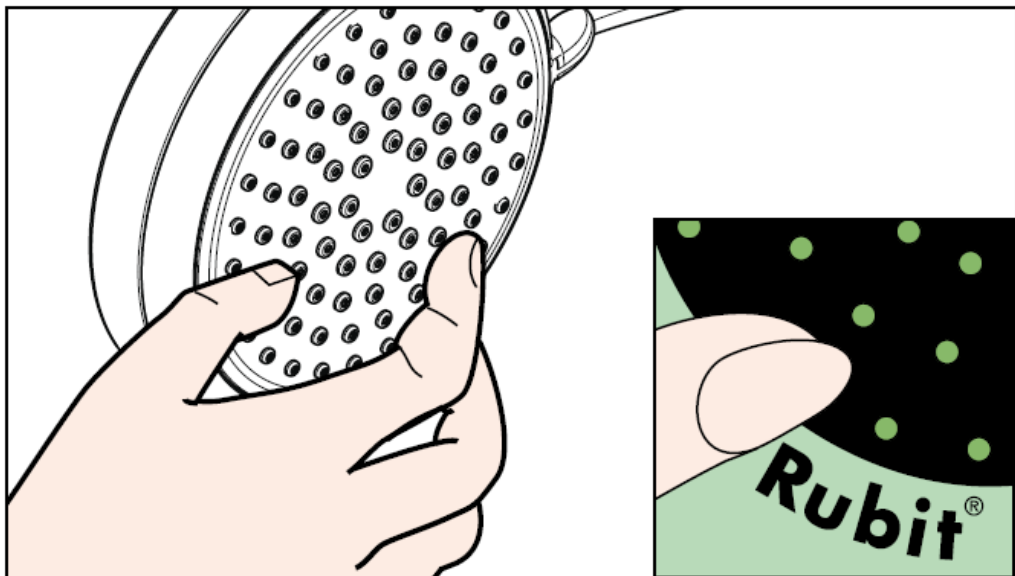

## Tisztítás

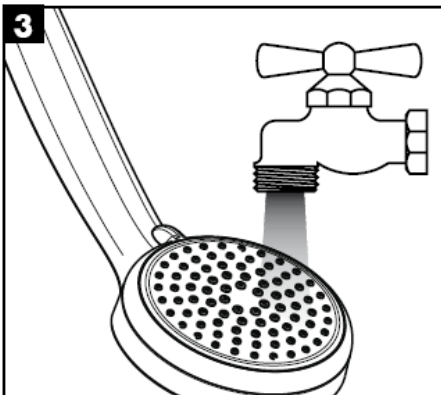
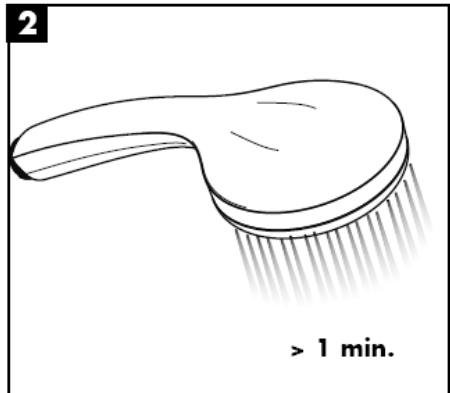
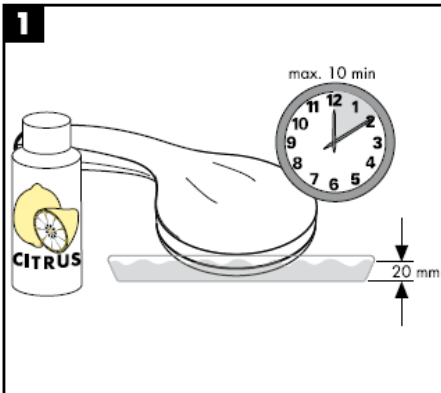
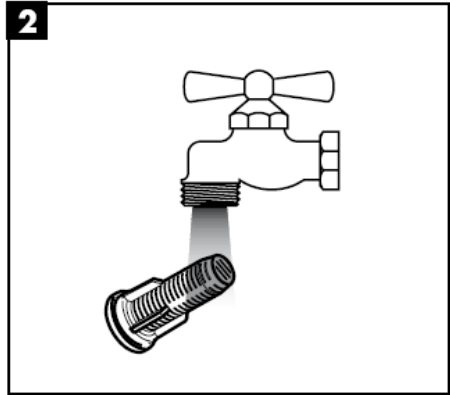
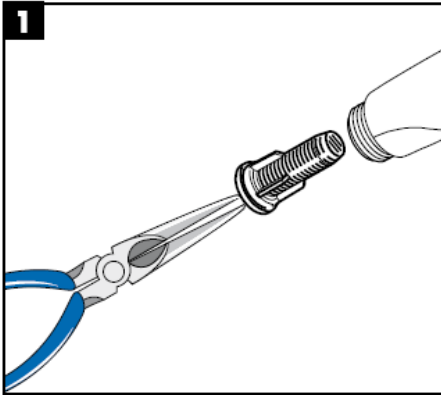

**hansgrohe**





# Asennusohje

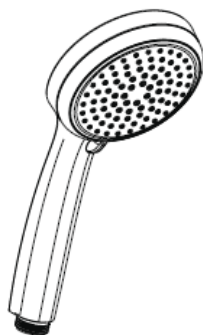

**Cromo 100  
Vario**  
28535000



**Cromo 100  
Multi**  
28536000

**hansgrohe**

**Croma 100 Vario**  
28535000

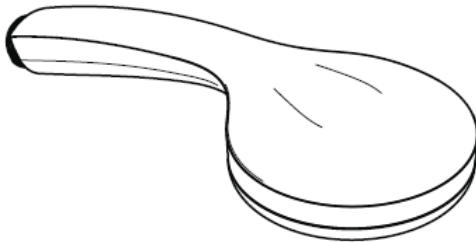

Massage



Shampoo



Normal



Rain

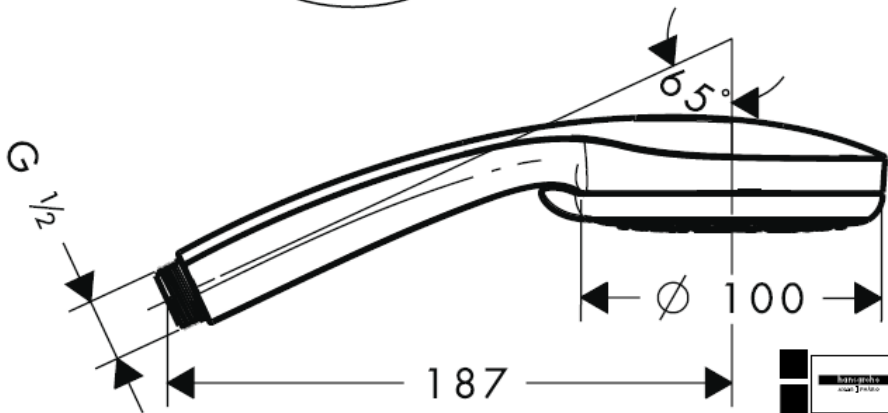

28535000

**Croma 100 Multi**  
28536000



Rain



Mono



Massage

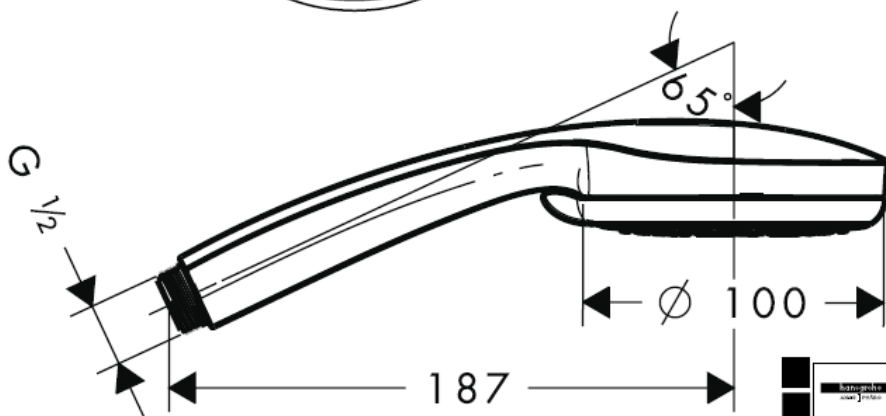

28536000

**Tekniset tiedot**

Käyttöpaine: max. 0,6 MPa  
 Suositeltu käyttöpaine: 0,1 – 0,4 MPa  
 (1 MPa = 10 bar = 147 PSI)  
 Kuuman veden lämpötila: max. 60° C

	DVGW	P-IX	SVGW	ACS	NF	WRAS	KIWA
28535000		P-IX 18335/ID	X	X			X
28536000		P-IX 18336/ID	X	X			X

**Asennus**

Käsisuihkun mukana toimitettu suodatinpatruuna (A) on asennettava paikalleen, jotta käsisuihkun normaalivirtaus olisi taattuna ja, jotta lian huuhtoutuminen vesijohtoverkostosta käsisuihkuun estyy. Jos halutaan suurempaa vesimäärää, suodatinpatruunan (A) tilalle voidaan asentaa sihtitiiviste (B). Huuhtoutuvat likahiukkaset voivat häiritä suihkun toimintaa tai vahingoittaa toimintaosia, Hansgrohe ei vastaa tästä aiheutuneista vahingoista.

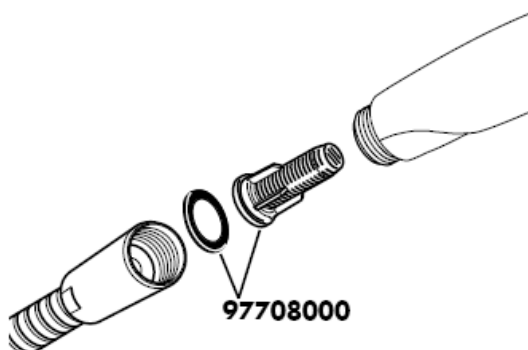

## Croma 100 Vario



Tämä toiminta on taattuna • alkaen.

## Croma 100 Multi

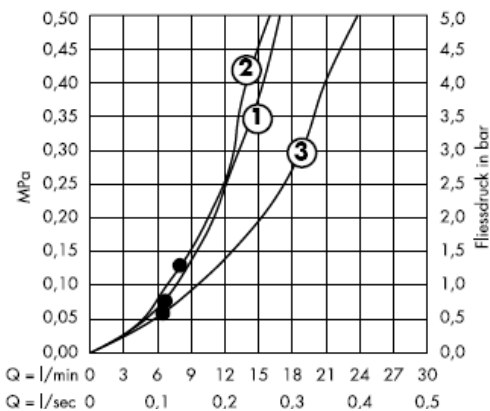

Tämä toiminta on taattuna • alkaen.

Käsिसuihku soveltuu käytettäväksi sellaisen läpivirtauskuumentimen yhteydessä, jonka teho on vähintään 21 kW ja läpivirtausmäärä vähintään 7 l/min.

## Puhdistus

Rubit® –käsitoiminen kalkinpoistojärjestelmä on helppo käyttää: hiero sormella ja vedentulo on taas esteetön.

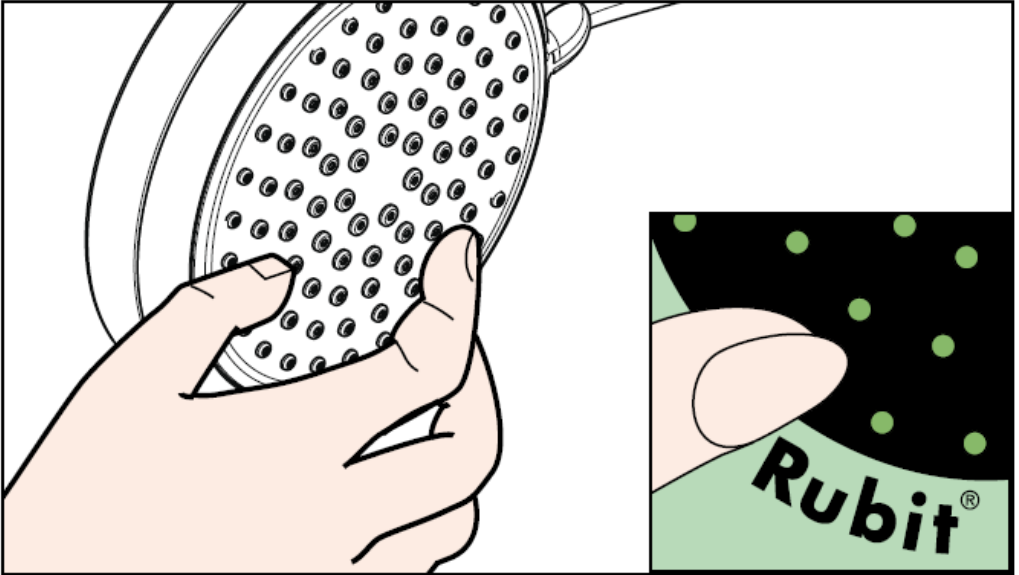

## Puhdistus

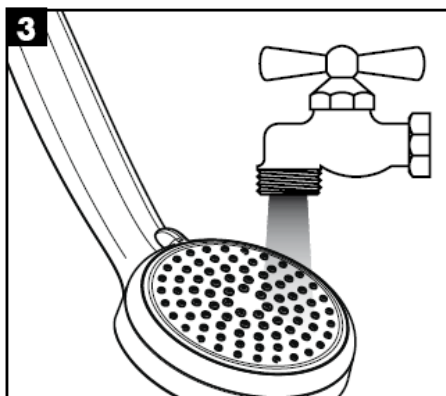
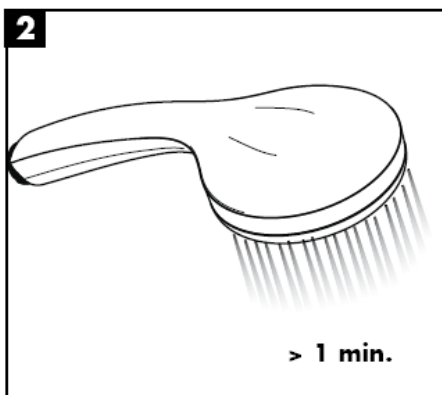
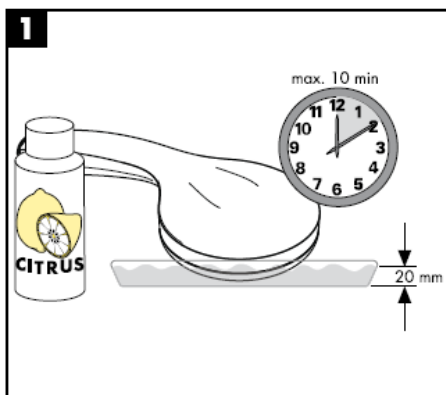
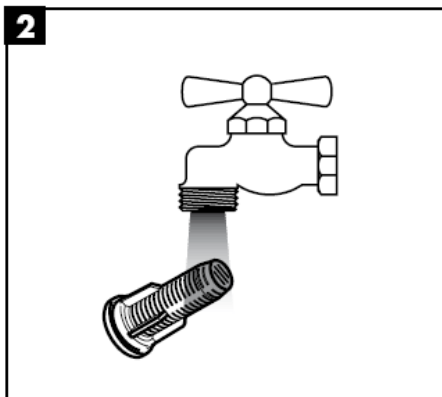
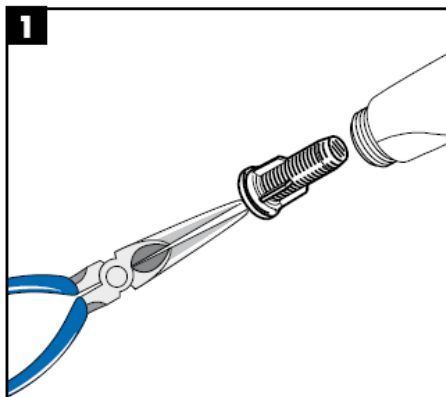

**hansgrohe**





# Monteringsanvisning

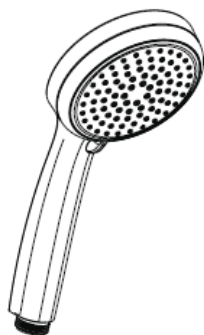

**Cromo 100  
Vario**  
28535000



**Cromo 100  
Multi**  
28536000

**hansgrohe**

**Croma 100 Vario**  
28535000

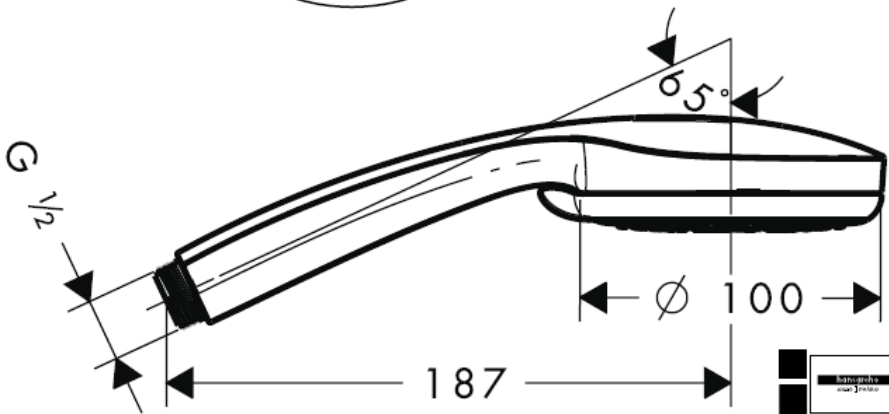
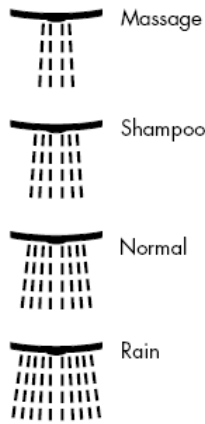

28535000

**Croma 100 Multi**  
28536000



Rain



Mono



Massage

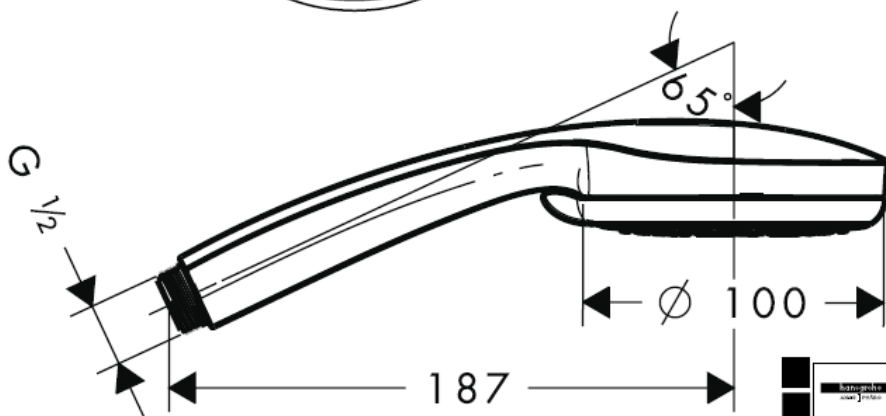

28536000

**Tekniska data**

Driftstryck: max. 0,6 MPa  
 Rek. driftstryck: 0,1 – 0,4 MPa  
 (1 MPa = 10 bar = 147 PSI)  
 Varmvattentemperatur: max. 60° C

	DVGW	P-IX	SVGW	ACS	NF	WRAS	KIWA
28535000		P-IX 18335/ID	X	X			X
28536000		P-IX 18336/ID	X	X			X

**Montering**

Filterinsatsen (A) som följer med måste monteras om normalflödet hos handduschen ska vara garanterat och för att undvika att smuts spolats in från ledningsnätet. Önskas kraftigare vattenflöde måste silpackningen (B) användas istället för filterinsatsen (A). Smuts som spolats in kan påverka funktionerna och/eller leda till skador på funktionsdelar i handduschen. Hansgrohe fränsäger sig allt ansvar för skador som kan härledas till detta.

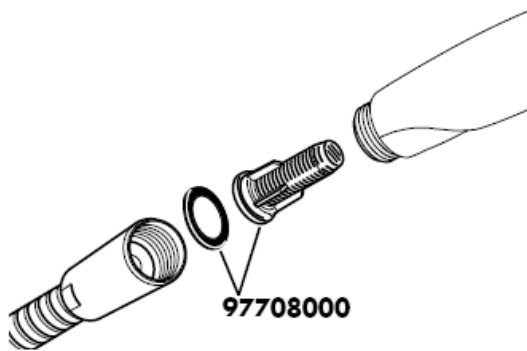

## Croma 100 Vario

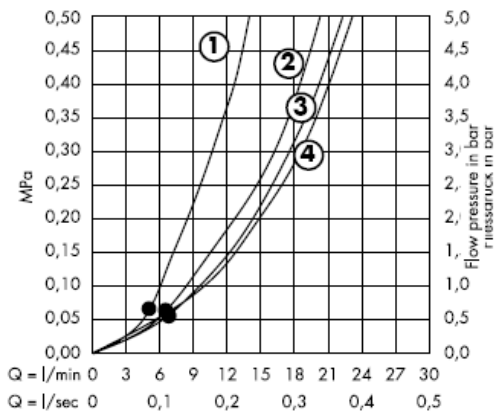

Från • garanteras funktionen.

## Croma 100 Multi

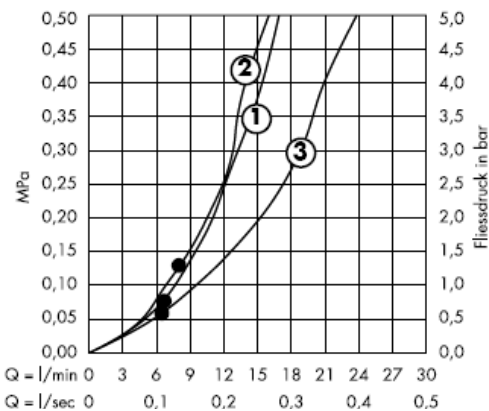

Från • garanteras funktionen.

Handduschen är avsedd för användning med vattenberedare som har en effekt från 21 kW och ett minsta genomflöde på 7 l/min.

## Rengöring

Med Rubit®, den manuella rengöringsfunktionen, är det lätt att befria strålkanelerna från kalk - de ska bara gnuggas.

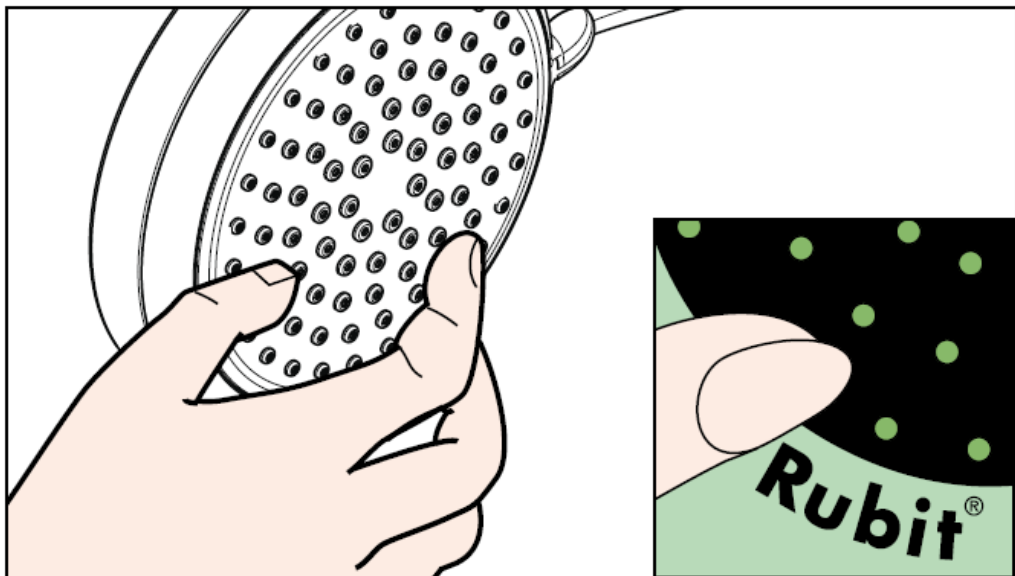

## Rengöring

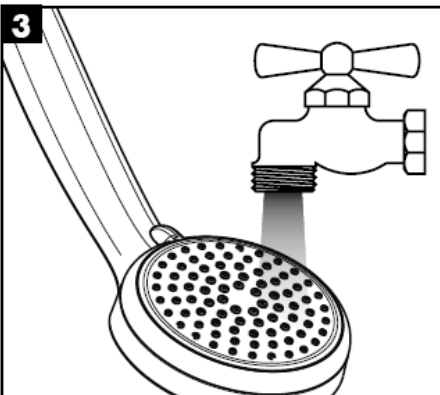
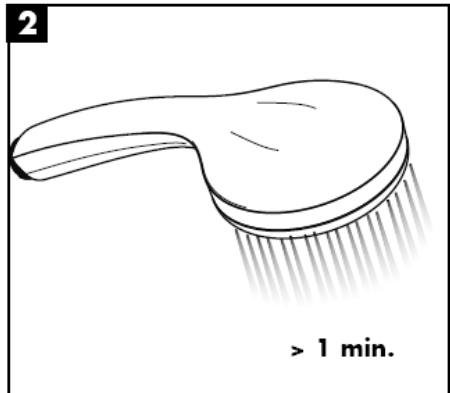
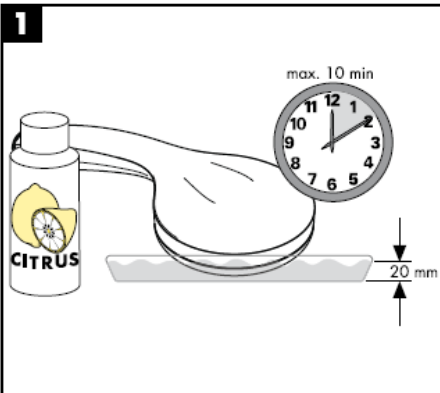
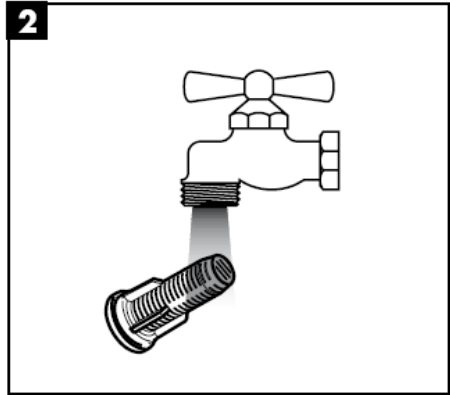
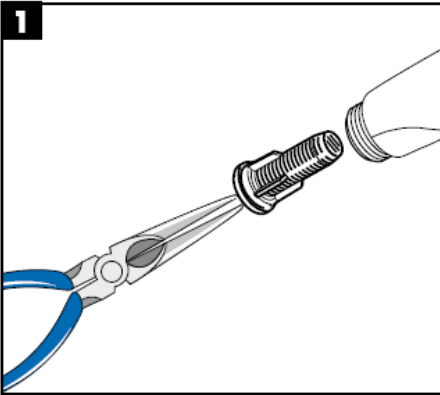

**hansgrohe**





# Montavimo instrukcijos

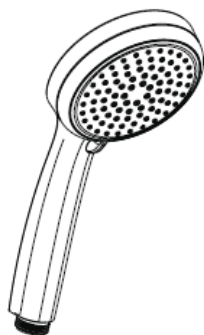

**Cromo 100  
Vario**  
28535000



**Cromo 100  
Multi**  
28536000

**hansgrohe**

**Croma 100 Vario**  
28535000



Massage



Shampoo



Normal



Rain

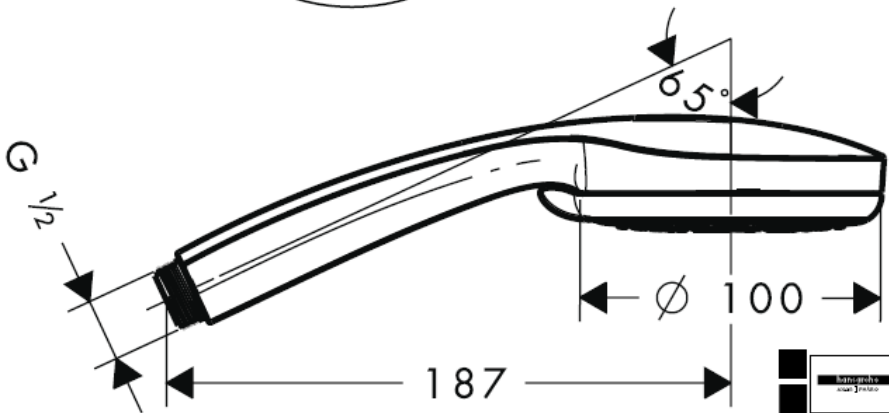

28535000

**Croma 100 Multi**  
28536000



Rain



Mono



Massage

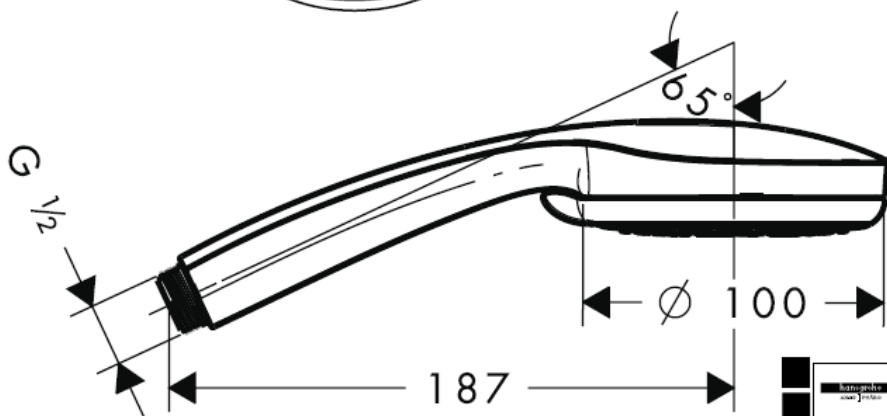

28536000

**Techniniai duomenys**

Darbinis slėgis: max. 0,6 MPa  
 Rekomenduojamas slėgis: 0,1 – 0,4 MPa  
 (1 MPa = 10 barų = 147 PSI)  
 Karšto vandens temperatūra: max. 60° C

	DVGW	P-IX	SVGW	ACS	NF	WRAS	KIWA
28535000		P-IX 18335/ID	X	X			X
28536000		P-IX 18336/ID	X	X			X

**Montavimas**

Filtras (A), kuris yra rankų dušass pakuotėje, privalo būti įstatytas, kad būtų garantuota vandens pralaidumo norma ir apsauga nuo nešvarumų. Jei reikia didesnio vandens pralaidumo, vietoje filtro (A) įstatykite sietelį (B). Nešvarumai gali pakenkti rankų dušass funkcionalumui ir (arba) sugadinti rankų dušass funkcines dalis. Tokiu atveju ""Hansgrohe"" atsakomybės neprisiima.

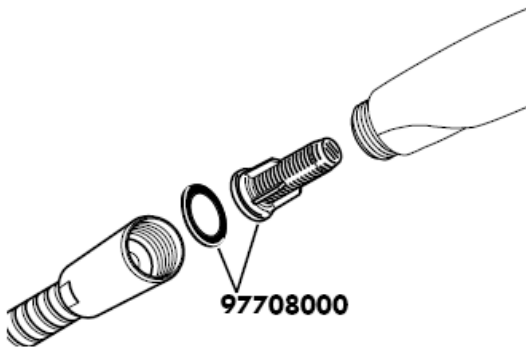

## Croma 100 Vario



Nuo • funkcionavimas garantuotas

## Croma 100 Multi

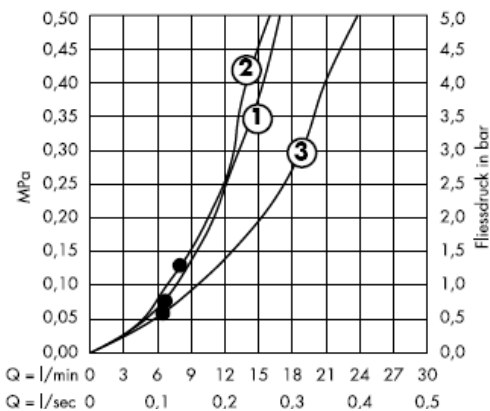

Nuo • funkcionavimas garantuotas

Dušo galvutė pritaikyta momentiniam vandens šildikliui nuo 21 kW su ne mažesniu kaip 7 l/min vandens pralaidumu.

## Valymas

"Rubit®" valymo funkcija apsaugo nuo apkalkėjimo. Užtenka pirštu nubraukti atsiradusius nešvarumus nuo srovės angų.

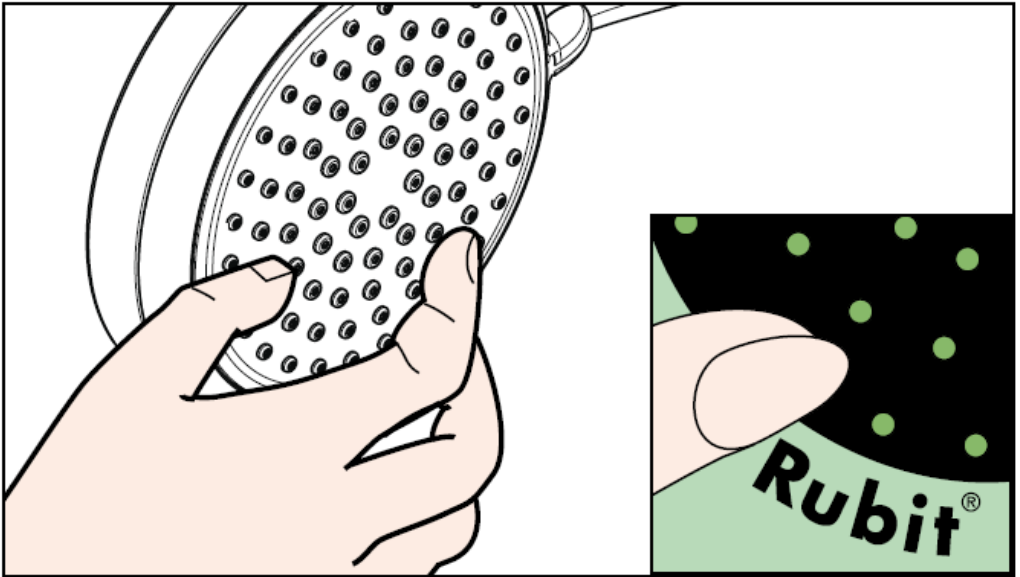

# Valymas

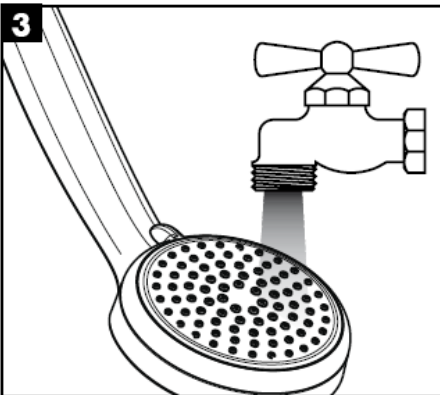
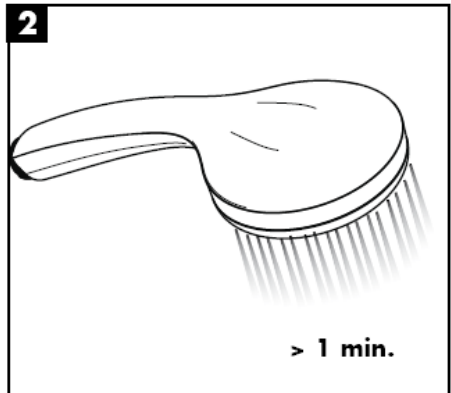
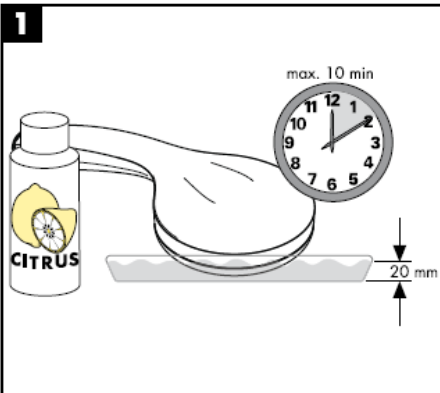
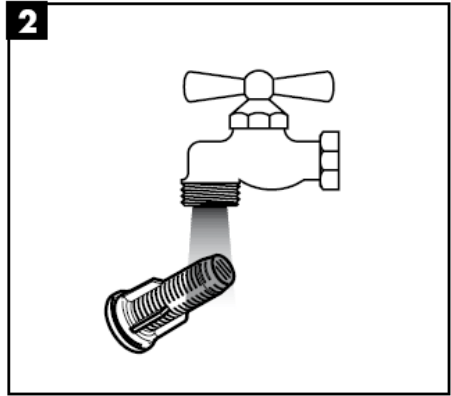
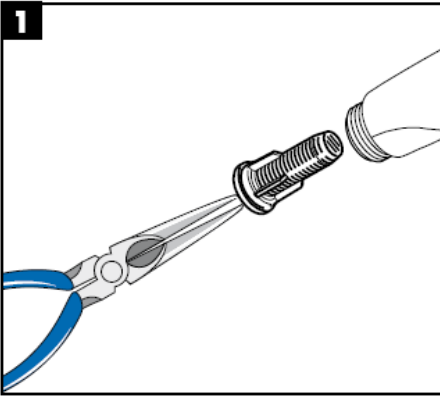

**hansgrohe**





# Uputstva za instalaciju

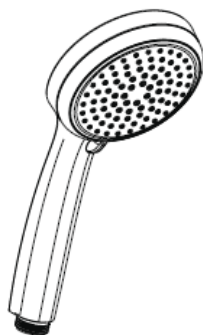

**Croma 100  
Vario**  
28535000



**Croma 100  
Multi**  
28536000

**hansgrohe**

**Croma 100 Vario**  
28535000

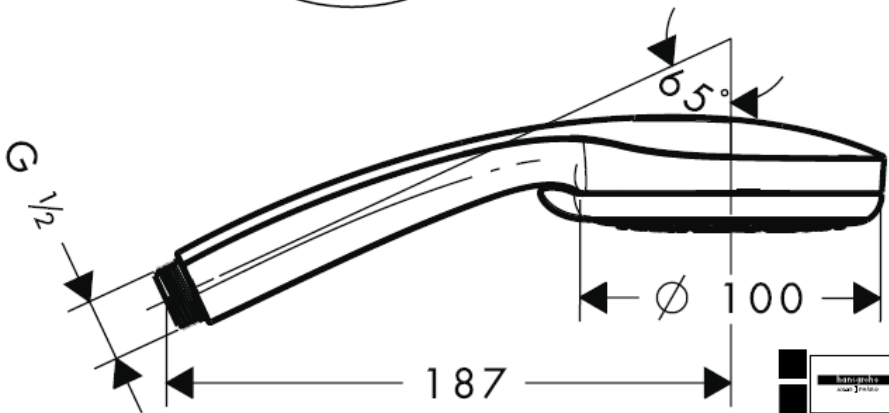

28535000

**Croma 100 Multi**  
28536000



Rain



Mono



Massage

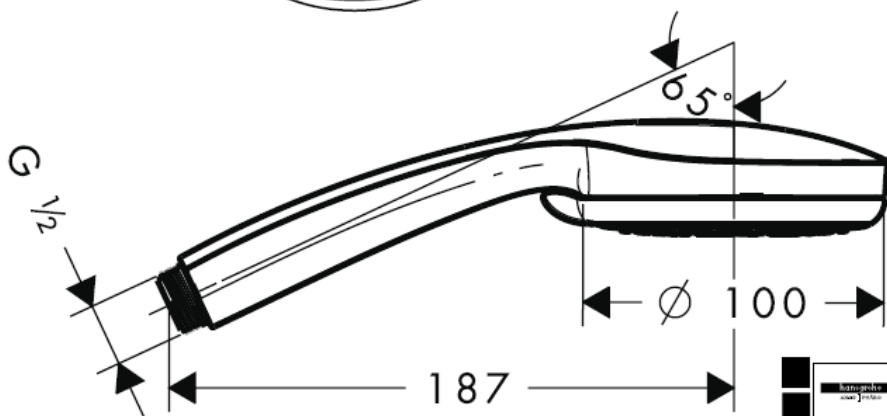

28536000

**Tehnički podatci**

Najveći dopušteni tlak: max. 0,6 MPa  
 Preporučeni tlak: 0,1 – 0,4 MPa  
 (1 MPa = 10 bara = 147 PSI)  
 Temperatura vruće vode: max. 60° C

	DVGW	P-IX	SVGW	ACS	NF	WRAS	KIWA
28535000		P-IX 18335/ID	X	X			X
28536000		P-IX 18336/ID	X	X			X

**Sastavljanje**

Filter (A) potrebno je ugraditi kako bi se regulirao protok vode i smanjio prolazak prljavštine. Ako želite jači protok vode umjesto filtera ugradite rešetku (B). Za eventualna oštećenja uzrokovana prljavštinom proizvođač Hansgrohe nije odgovoran.

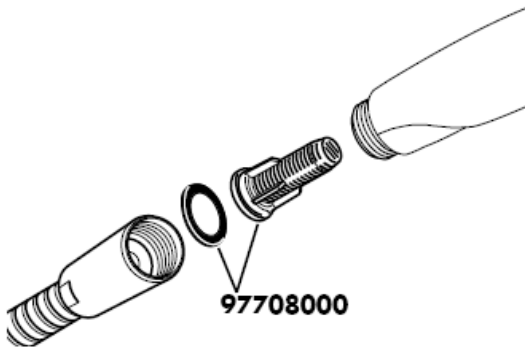

## Croma 100 Vario



Zajamčena funkcija od • naviše

## Croma 100 Multi

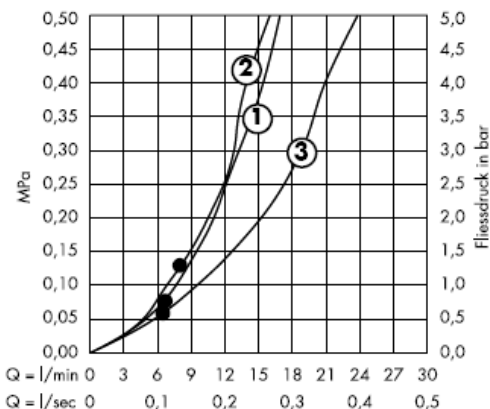

Zajamčena funkcija od • naviše

Ručni tuš možete koristiti uz protočni bojler od 21 kW te uz minimalni protok od 7 litara u minuti

## Čišćenje

Rubit® - ručni sustav za čišćenje omogućuje jednostavnim trljanjem odstranjivanje kamenca sa rupica prskalice tuša.

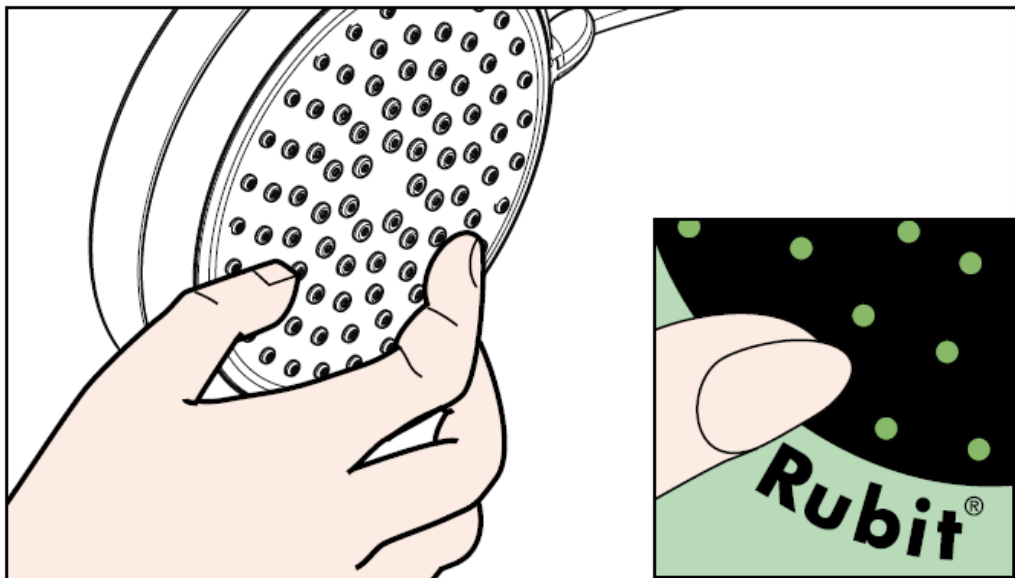

## Čišćenje

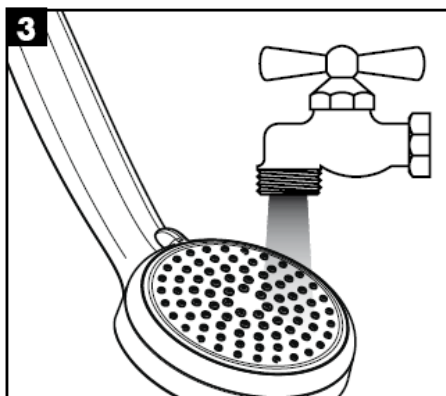
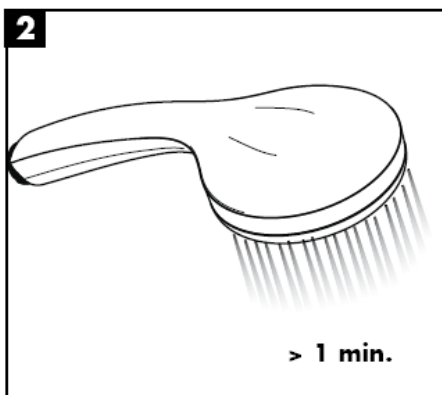
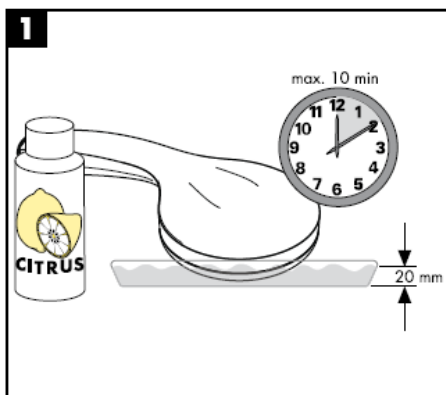
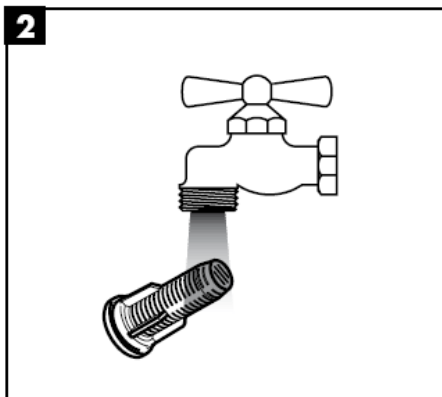
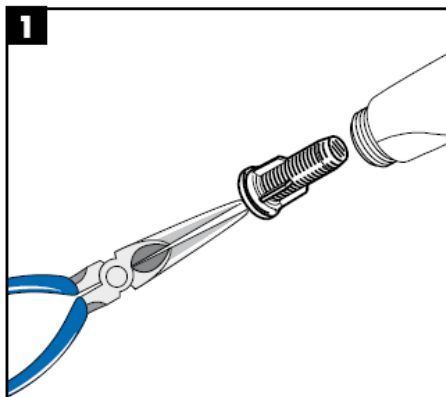

**hansgrohe**





# Montaj kılavuzu

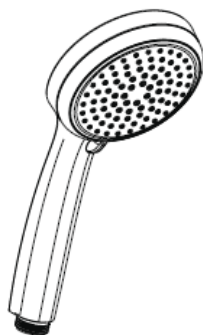

**Cromo 100  
Vario**  
28535000



**Cromo 100  
Multi**  
28536000

**hansgrohe**

**Croma 100 Vario**  
28535000

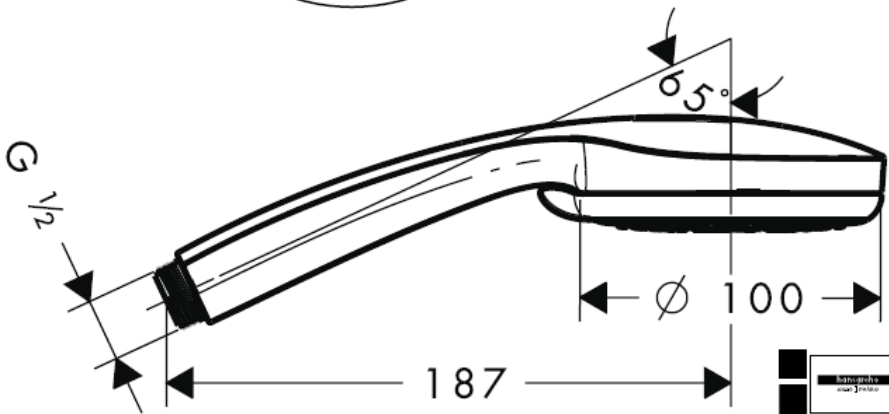
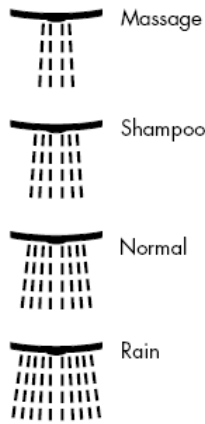

28535000

**Croma 100 Multi**  
28536000



Rain



Mono



Massage

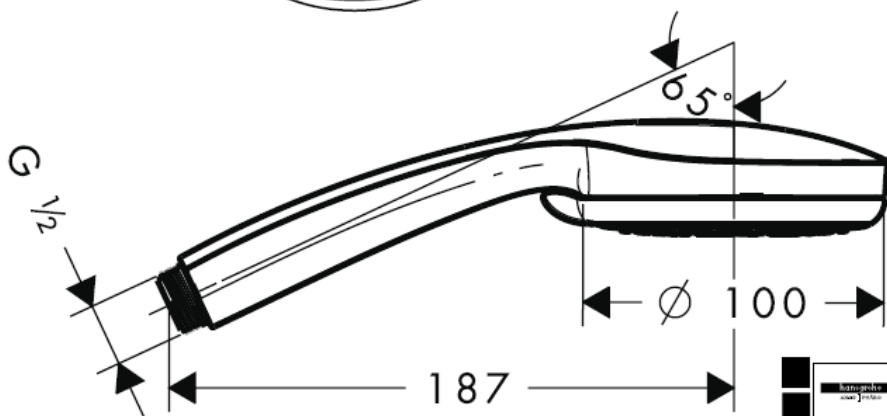

28536000

### Teknik bilgiler

İşletme basıncı: max. 0,6 MPa  
Tavsiye edilen işletme basıncı: 0,1 – 0,4 MPa  
(1 MPa = 10 bar = 147 PSI)  
Sıcak su sıcaklığı: max. 60° C

	DVGW	P-IX	SVGW	ACS	NF	WRAS	KIWA
28535000		P-IX 18335/ID	X	X			X
28536000		P-IX 18336/ID	X	X			X

### Montajı

El duşunun norm debisini sağlamak ve şebekeden kir gelmesini önlemek için, ekteki filtre adaptörü (A) takılmalıdır. Daha büyük bir su debisi istenirse, filtre adaptörünün (A) yerine bir süzgeç contası (B) takılmalıdır. Şebekeden gelen kirler çalışmayı etkileyebilir ve/veya el duşundaki fonksiyon parçalarının zarar görmesine neden olabilir; bu nedenle oluşan hasarlar için Hansgrohe hiçbir sorumluluk üstlenmez.

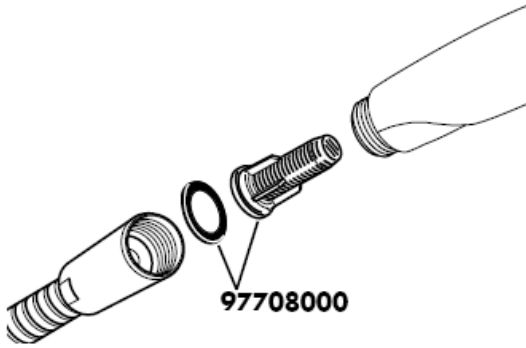

## Croma 100 Vario

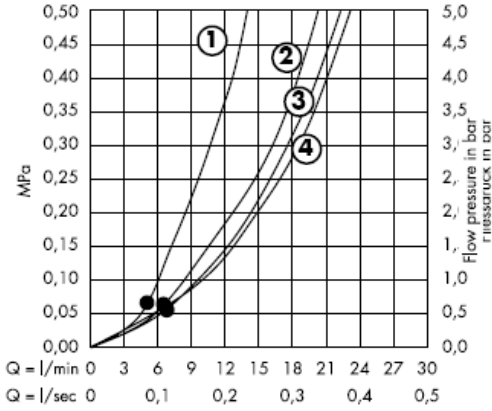

•den itibaren fonksiyon garanti edilmiştir.

## Croma 100 Multi

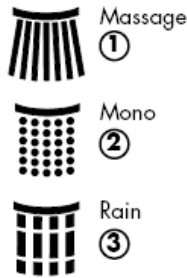
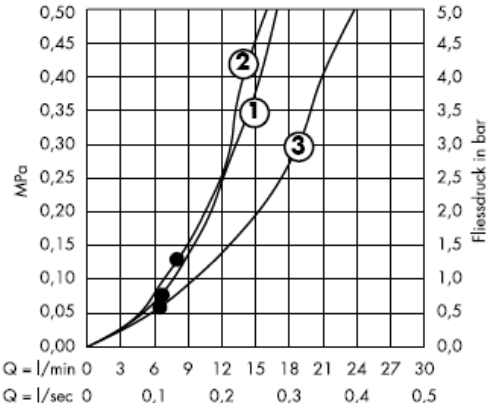

•den itibaren fonksiyon garanti edilmiştir.

El duşu, 21 kW güçten ve 7 l/dk minimum debiden itibaren şofbenlerle kullanım için uygundur.

## Temizleme

Rubit®, üründe bulunan bir temizleme fonksiyonudur. Basit bir ovuşturma ile spray modüllerdeki kireci çözer.

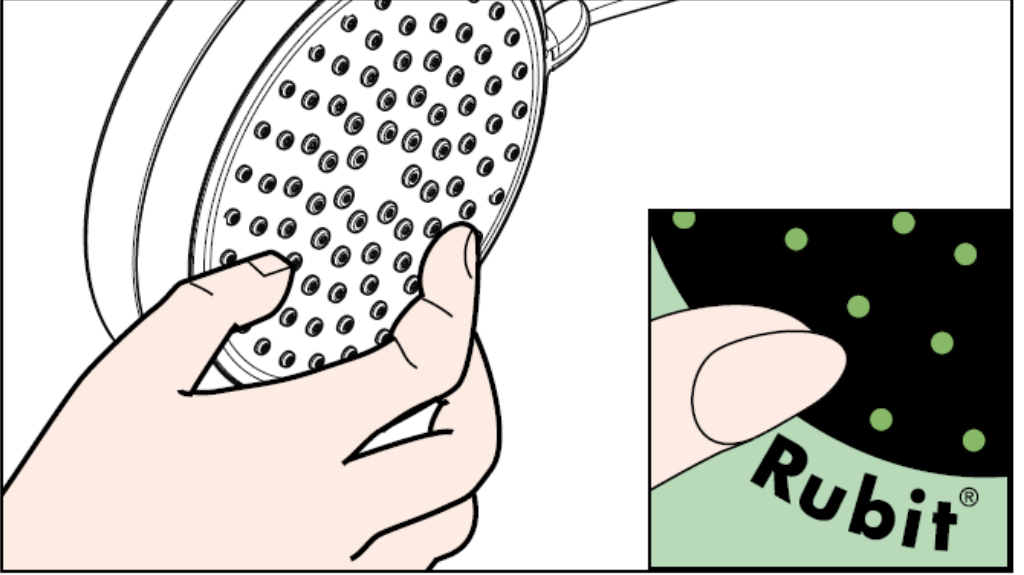

## Temizleme

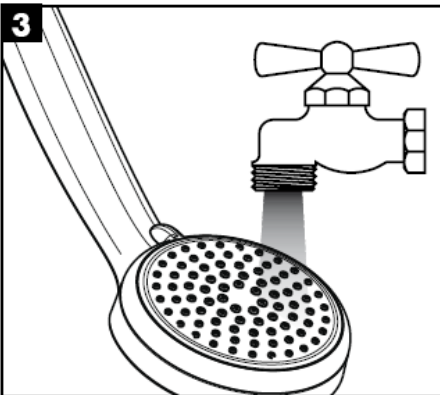
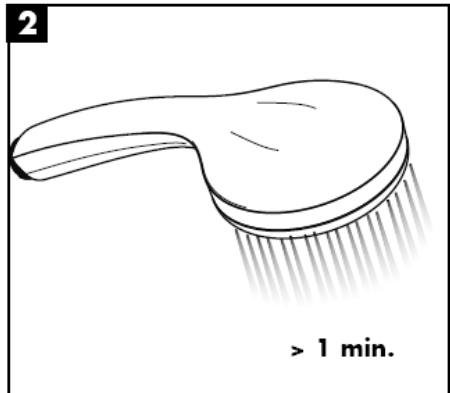
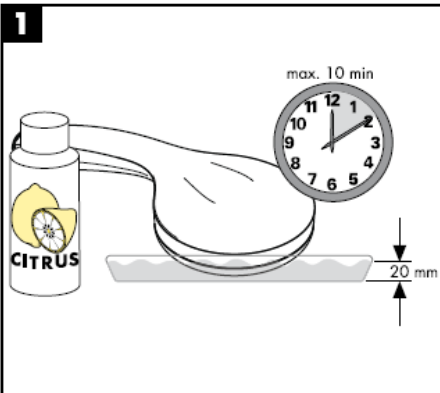
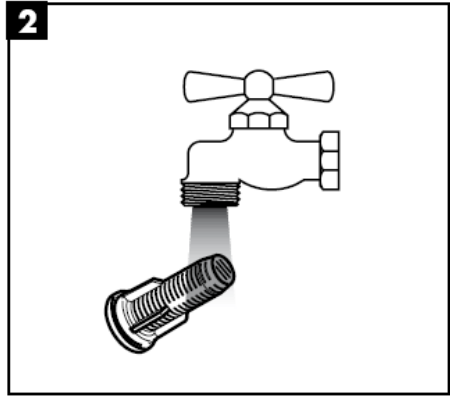
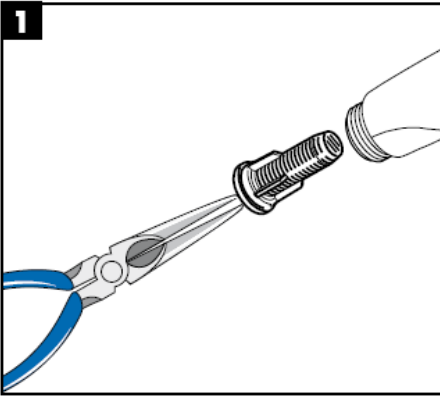

**hansgrohe**





# Instrucțiuni de montare

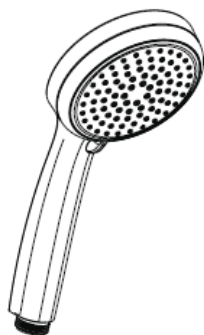

**Croma 100  
Vario**  
28535000



**Croma 100  
Multi**  
28536000

**hansgrohe**

**Croma 100 Vario**  
28535000

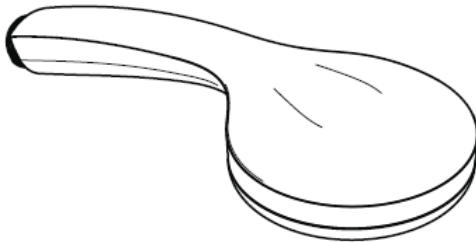

Massage



Shampoo



Normal



Rain

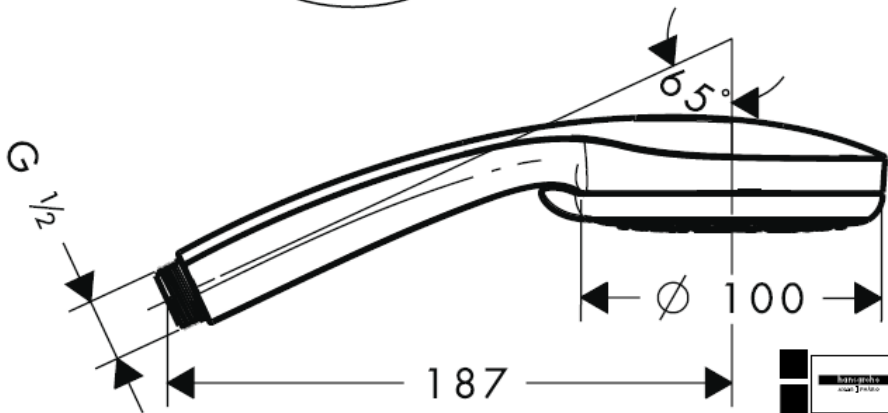

28535000

**Croma 100 Multi**  
28536000

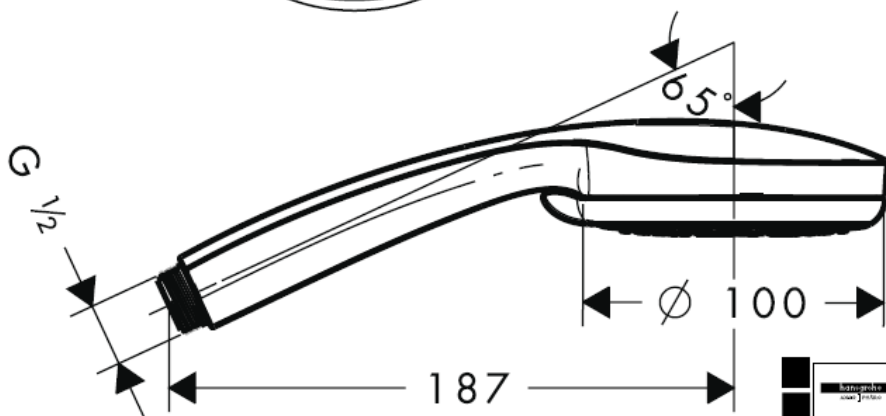
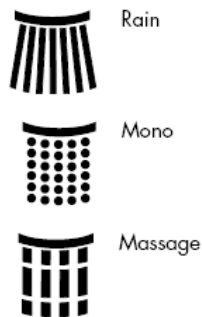

28536000

**Date tehnice**

Presiune de funcționare: max. 0,6 MPa  
 Presiune de funcționare recomandată: 0,1 – 0,4 MPa  
 (1 MPa = 10 bar = 147 PSI)  
 Temperatura apei calde: max. 60° C

	DVGW	P-IX	SVGW	ACS	NF	WRAS	KIWA
28535000		P-IX 18335/ID	X	X			X
28536000		P-IX 18336/ID	X	X			X

**Montare**

Montați garnitura de filtru (A) livrată cu aparatul pentru asigurarea funcționării corespunzătoare a dușului de mână și pentru evitarea pătrunderii impurităților din rețeaua de apă. Dacă doriți un debit mai mare de apă, montați garnitura sită (B) în locul garniturii de filtru (A). Impuritățile pătrunse pot influența funcționarea dușului de mână și/sau deteriora componentele acestuia, garanția nu acoperă daunele provocate din această cauză.

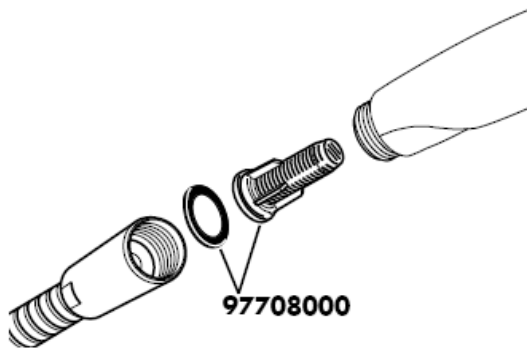

## Croma 100 Vario



Începând de la • funcționarea este garantată.

## Croma 100 Multi

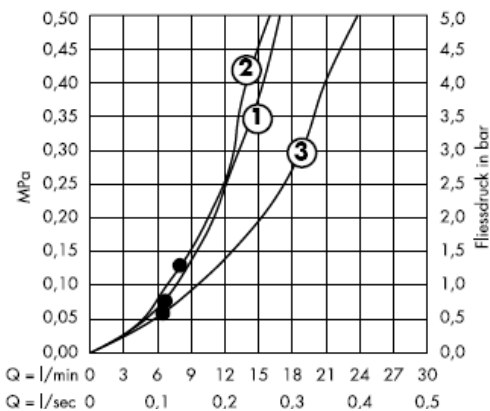

Începând de la • funcționarea este garantată.

Dușul de mână poate fi utilizat cu boiler instant de o putere de peste 21 kW și un debit de min. 7 l/min.

## Curățare

Cu ajutorul sistemului Rubit® puteți să îndepărtați depunerile de calcar de pe diferitele duze de jet de apă prin frecare.

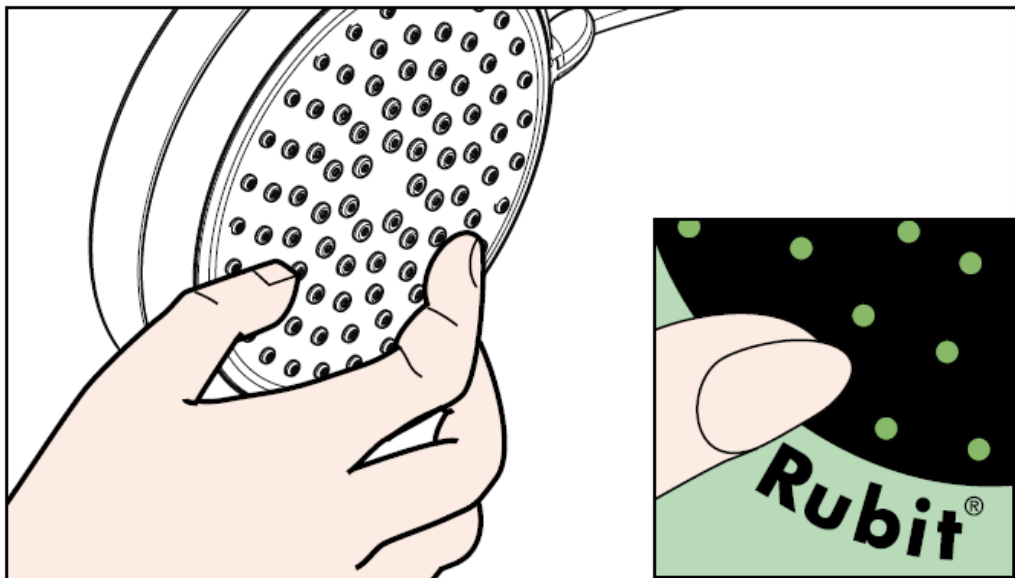

## Curățare

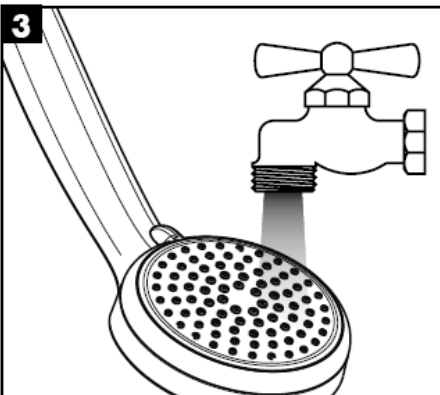
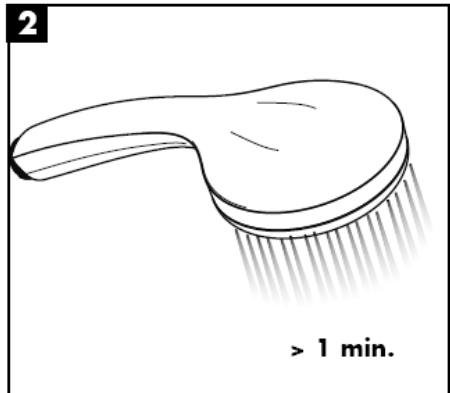
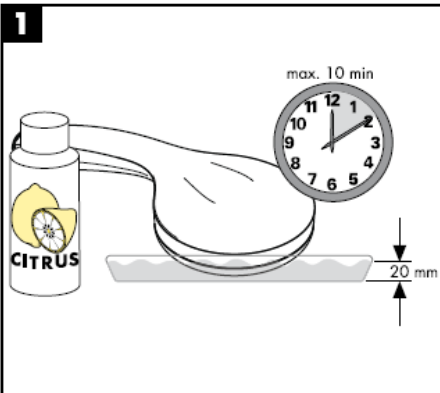
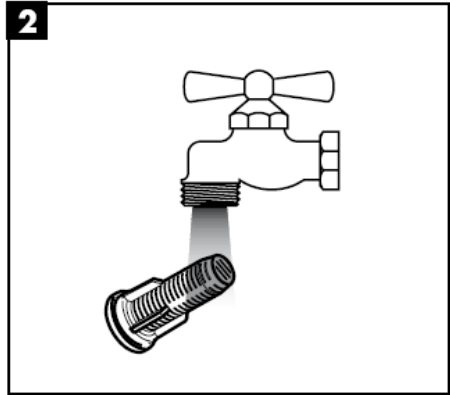
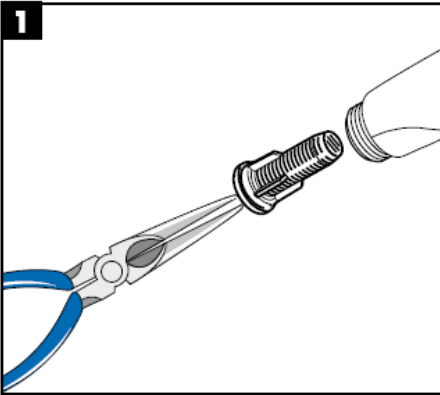

**hansgrohe**





# Οδηγία συναρμολόγησης

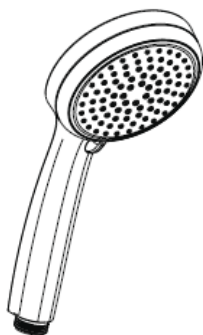

**Croma 100  
Vario**  
28535000

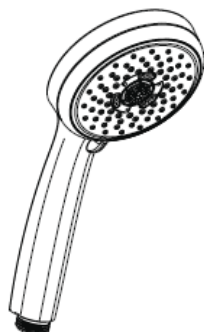

**Croma 100  
Multi**  
28536000

**hansgrohe**

**Croma 100 Vario**  
28535000

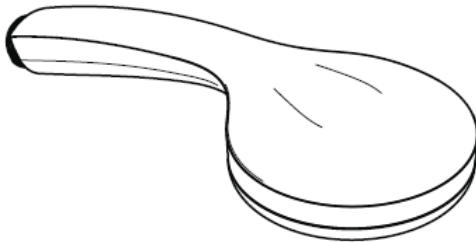

Massage



Shampoo



Normal



Rain

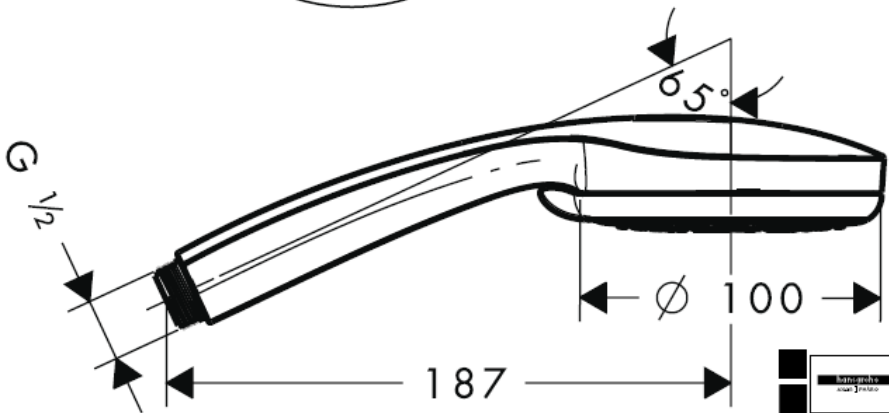

28535000

**Croma 100 Multi**  
28536000



Rain



Mono



Massage

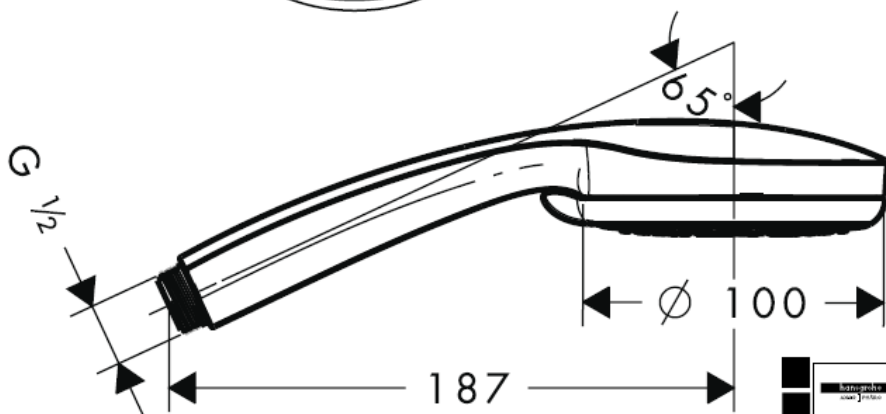

28536000

**Τεχνικά Χαρακτηριστικά**

Λειτουργία πίεσης: max. 0,6 MPa  
 Συνιστώμενη λειτουργία πίεσης: 0,1 – 0,4 MPa  
 (1 MPa = 10 bar = 147 PSI)  
 Θερμοκρασία ζεστού νερού: max. 60° C

	<b>DVGW</b>	<b>P-IX</b>	<b>SVGW</b>	<b>ACS</b>	<b>NF</b>	<b>WRAS</b>	<b>KIWA</b>
28535000		P-IX 18335/ID	X	X			X
28536000		P-IX 18336/ID	X	X			X

**Συναρμολόγηση**

Η συνοδευτική προσθήκη φίλτρου (A) πρέπει να εγκατασταθεί, προκειμένου να διασφαλίσει την κανονική ροή του καταιονιστήρα χειρός και να αποτρέψει την είσοδο ρύπων από το δίκτυο ύδρευσης. Εάν είναι επιθυμητή μία μεγαλύτερη ροή νερού, θα πρέπει, στη θέση της προσθήκης φίλτρου (A) να τοποθετηθεί το στεγανοποιητικό παρέμβυσμα (B). Η είσοδος ρύπων μπορεί να επηρεάσει δυσμενώς τη λειτουργία ή/και να προκαλέσει βλάβες στα λειτουργικά σημεία του καταιονιστήρα χειρός, για τις όποιες ζημιές δεν αναλαμβάνει καμία ευθύνη η εταιρεία Hansgrohe.

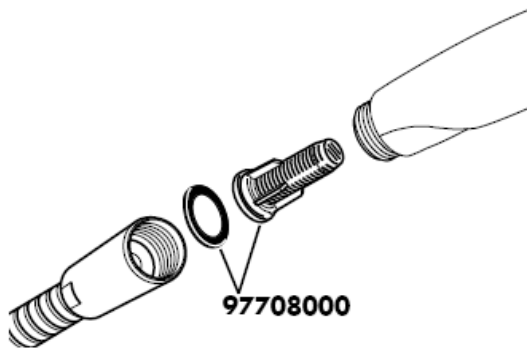

## Croma 100 Vario



Αυτή η λειτουργία διασφαλίζεται από το σημείο κι έπειτα

## Croma 100 Multi

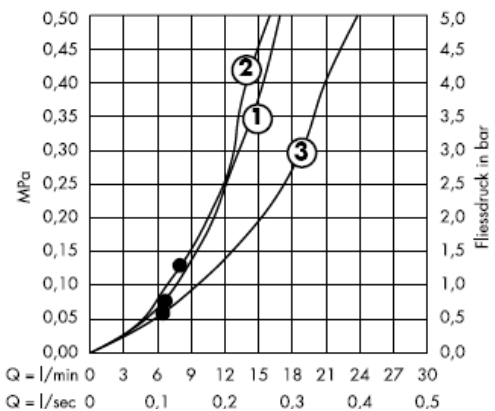

Αυτή η λειτουργία διασφαλίζεται από το σημείο κι έπειτα

Ο καταιονιστήρας χειρός είναι κατάλληλος για χρήση με ταχυθερμοσίφωνες, από μία απόδοση 21 kW και μία ελάχιστη ροή των 7L/min και άνω.

## Καθαρισμός

Με Rubit®, τη λειτουργία καθαρισμού με το χέρι, μπορούν να απομακρυνθούν με απλό τρίψιμο τα άλατα από τα κανάλια του καταιονιστήρα.

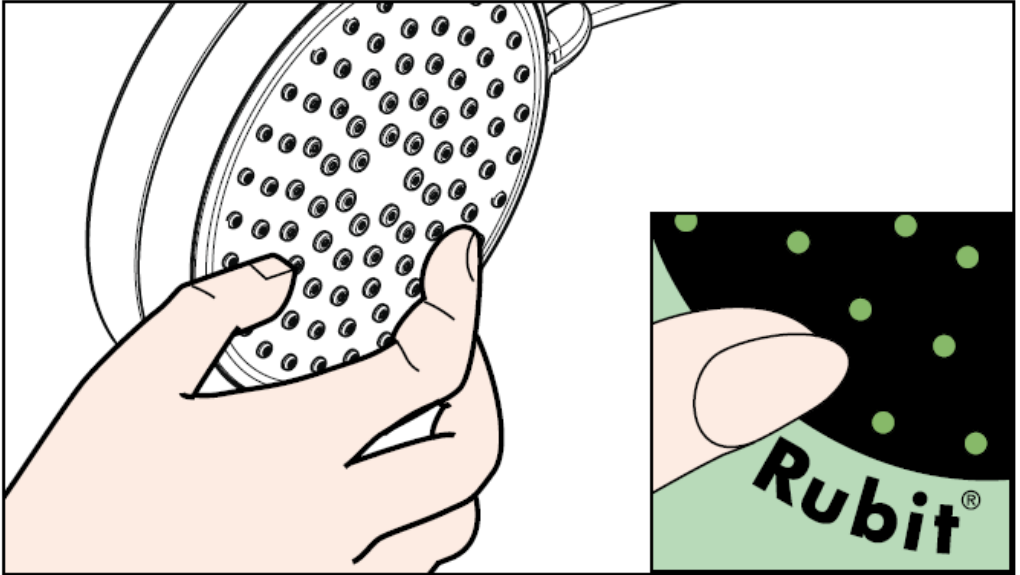

## Καθαρισμός

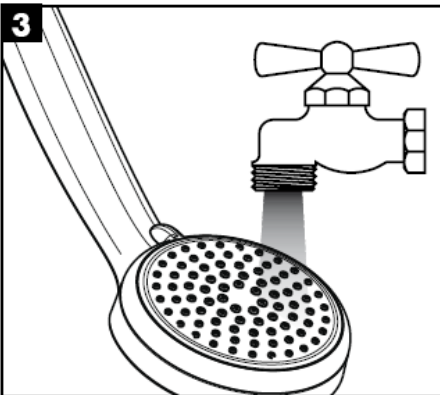
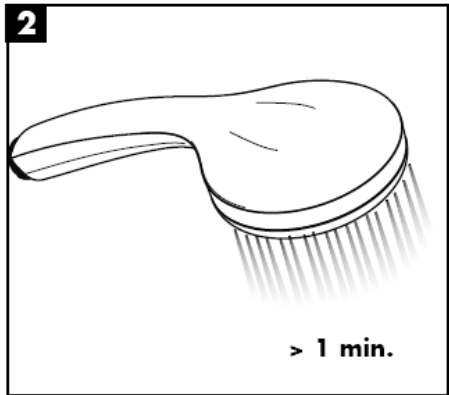
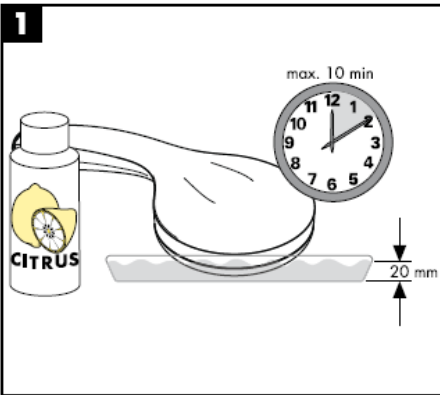
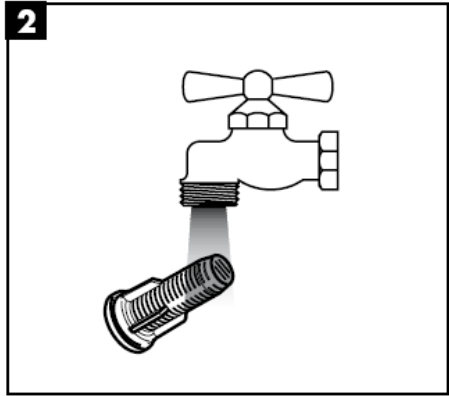
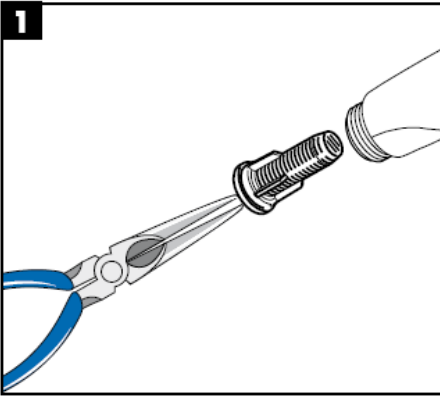

**hansgrohe**





# تعليمات التجميع

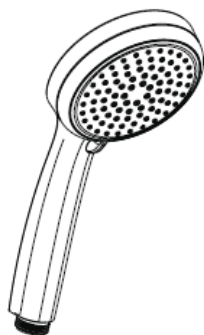

**Croma 100  
Vario**  
28535000



**Croma 100  
Multi**  
28536000

**hansgrohe**

**Croma 100 Vario**  
28535000

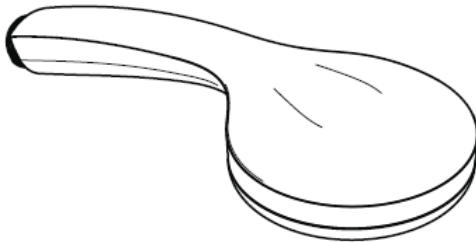

Massage



Shampoo



Normal



Rain

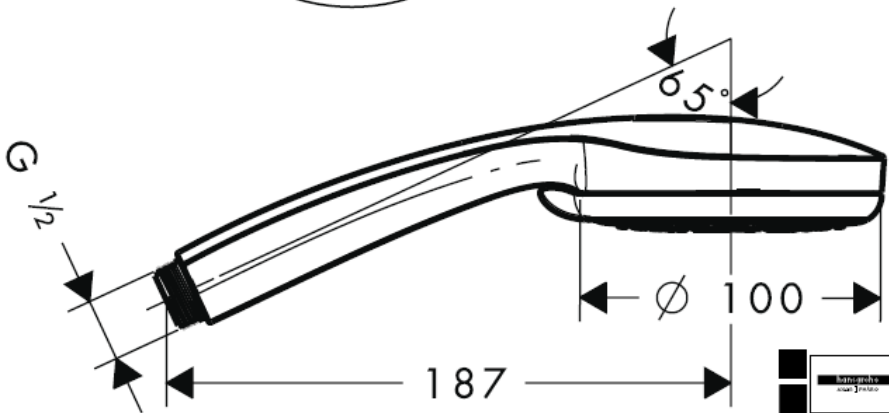

28535000

**Croma 100 Multi**  
28536000

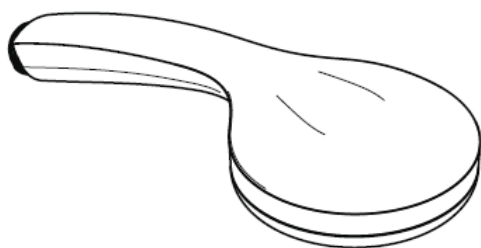
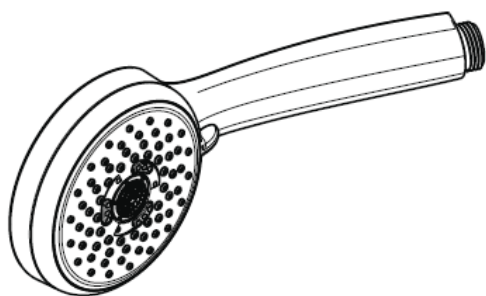

Rain



Mono



Massage

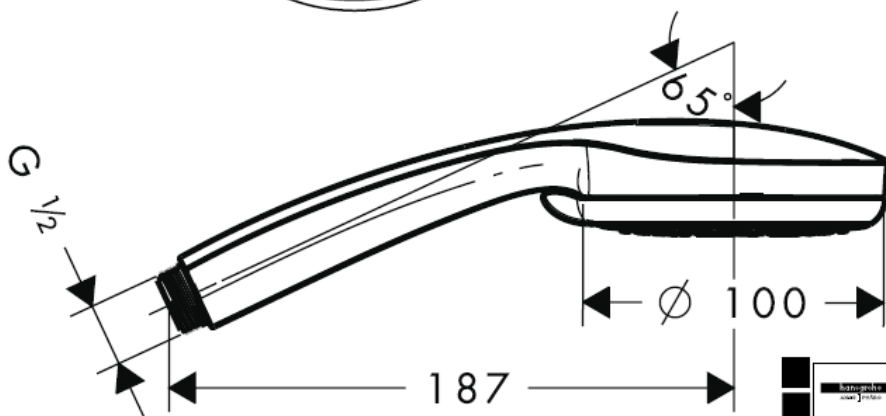

28536000

## المواصفات الفنية

max. 0,6 MPa  
0,1 – 0,4 MPa

ضغط التشغيل:  
ضغط التشغيل الموصى به:  
( 1 MPa = 147 PSI = 10 بار )  
درجة حرارة الماء الساخن:

max. 60° C

	DVGW	P-IX	SVGW	ACS	NF	WRAS	KIWA
28535000		P-IX 18335/ID	X	X			X
28536000		P-IX 18336/ID	X	X			X

## التركيب

يجب استخدام وليجة المرشح (A) لضمان الحصول على معدل التدفق القياسي وحماية الدش اليدوي من الأوساخ التي تحملها شبكة المواسير. هل تريد الحصول على معدل تدفق أعلى؟ إذن يجب أن تستخدم حشبة المرشح (B) بدلاً من وليجة المرشح (A). حيث تؤدي الأوساخ الواردة إلى حدوث أعطال أو / وقد تتسبب في تلف أجزاء من من الدش اليدوي، ومثل هذه الأعطال تلغي كافة المطالبات الخاصة بالمسؤولية أو الضمان.

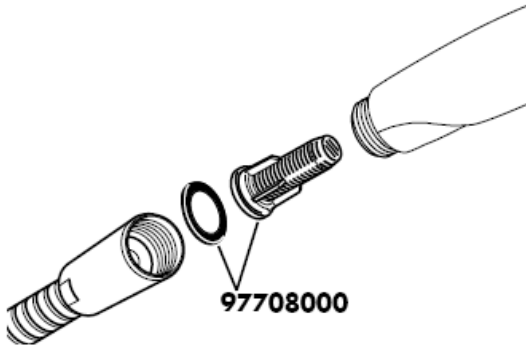

## Croma 100 Vario

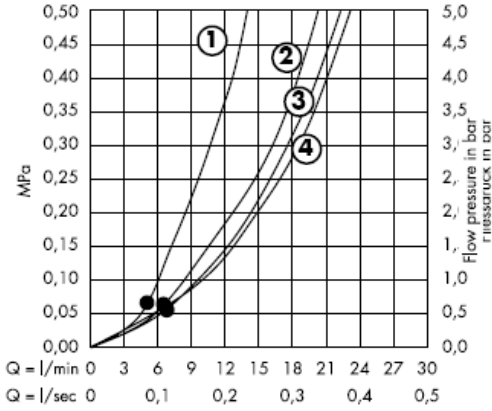

من • الوظيفة مضمونة.

## Croma 100 Multi

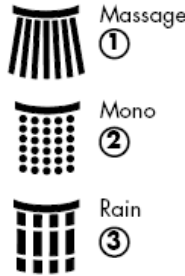
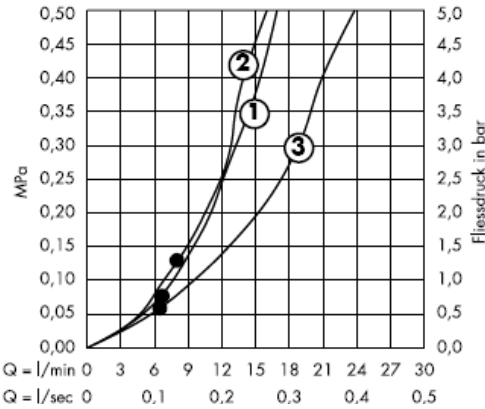

من • الوظيفة مضمونة.

يصلح الدش اليدوي للاستخدام مع سخانات المياه ذات التدفق المستمر التي يبلغ خرج الحرارة منها 21 كيلو وات وحد أدنى من التدفق المار بها يبلغ 7 لتر / الدقيقة.

لا تحتاج وظيفة تنظيف سوى قدر بسيط من الفرك باليد لإزالة القشور الجيرية من فتحات الرشاش.

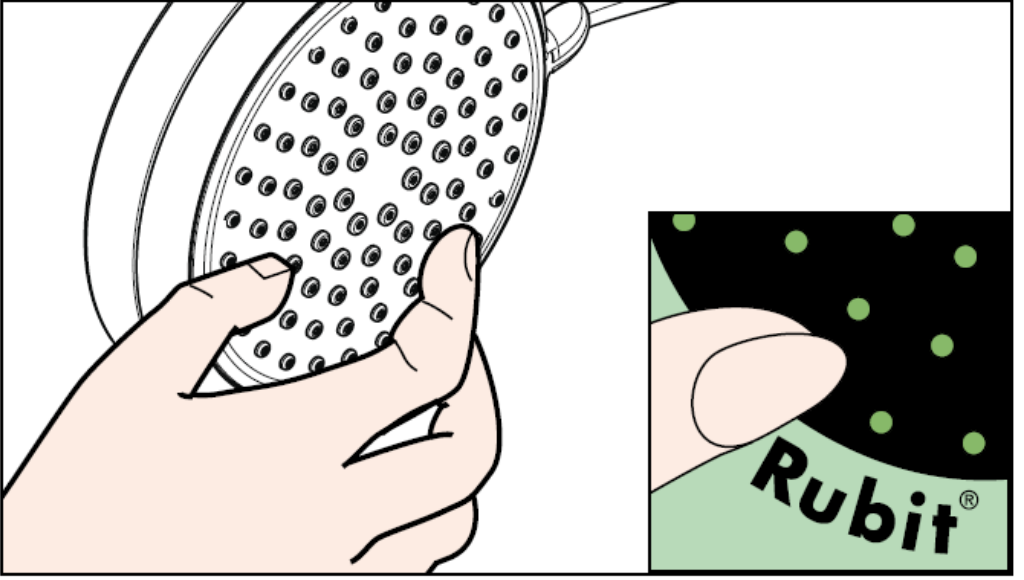

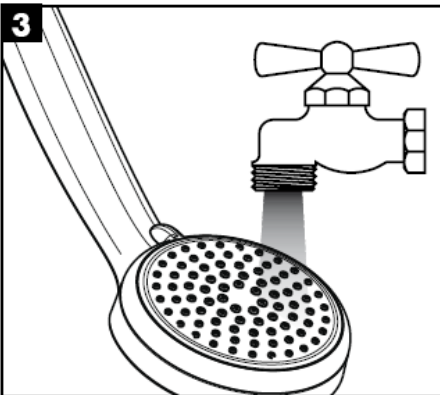
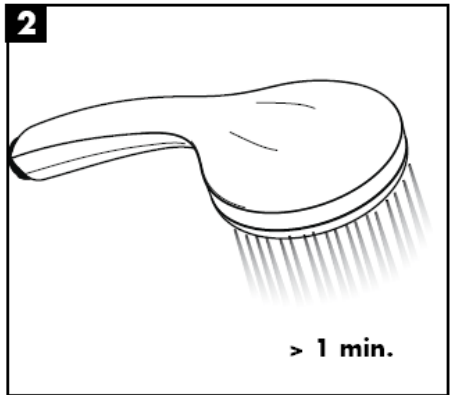
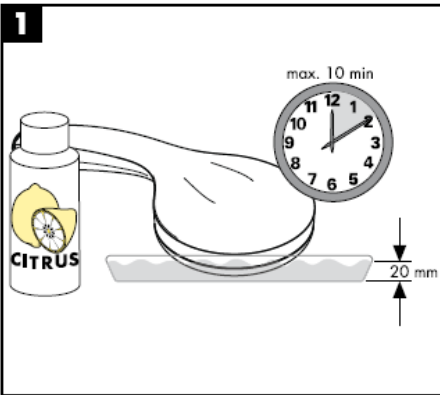
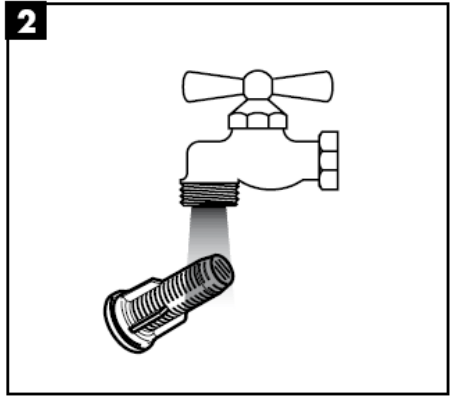
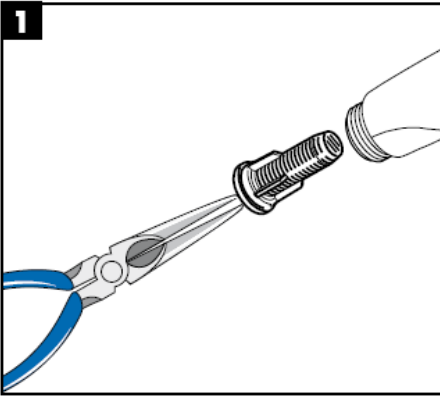

**hansgrohe**





# Navodila za montažo

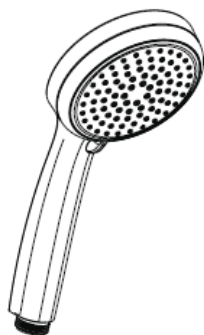

**Cromo 100  
Vario**  
28535000



**Cromo 100  
Multi**  
28536000

**hansgrohe**

**Croma 100 Vario**  
28535000



Massage



Shampoo



Normal



Rain

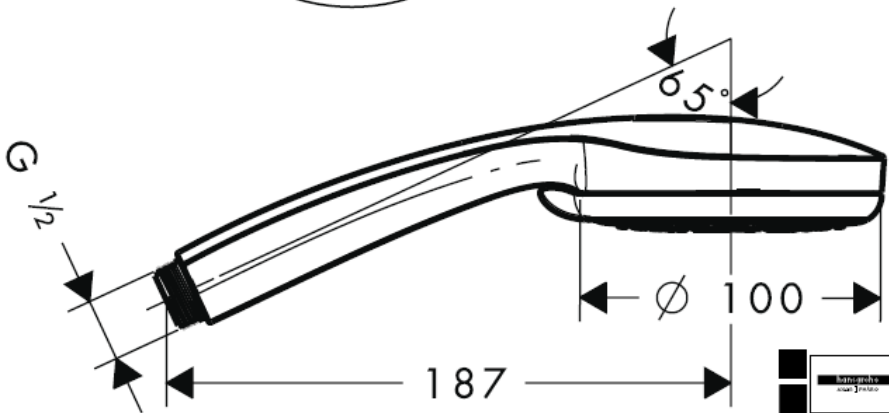

28535000

**Croma 100 Multi**  
28536000



Rain



Mono



Massage

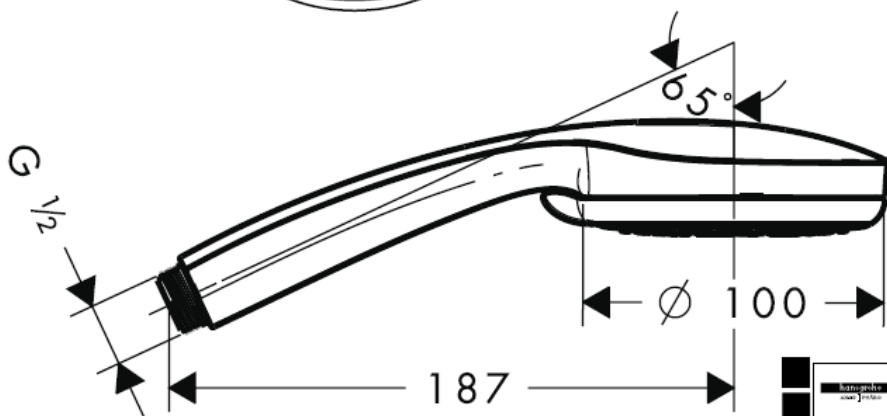

28536000

**Tehnični podatki**

Delovni tlak: max. 0,6 MPa  
 Priporočeni delovni tlak: 0,1 – 0,4 MPa  
 (1 MPa = 10 bars = 147 PSI)  
 Temperatura tople vode: max. 60° C

	DVGW	P-IX	SVGW	ACS	NF	WRAS	KIWA
28535000		P-IX 18335/ID	X	X			X
28536000		P-IX 18336/ID	X	X			X

**Montaža**

Priloženi filtrirni vložek (A) je potrebno vgraditi, da zagotovimo standardni pretok in zaščitimo ročno prho pred umazanijo iz vodovodne napeljave. Če želite večji pretok vode, je namesto filtrirnega vložka (A) potrebno vstaviti filtrirno mrežico (B). Umazanija lahko okvari ali poškoduje dele ročne prhe. Za tako nastalo škodo Hansgrohe ne odgovarja.

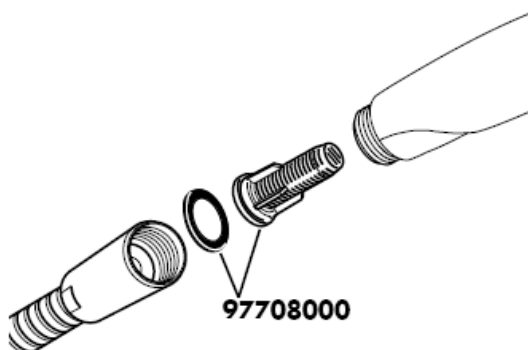

## Croma 100 Vario



Od • je delovanje zagotovljeno.

## Croma 100 Multi

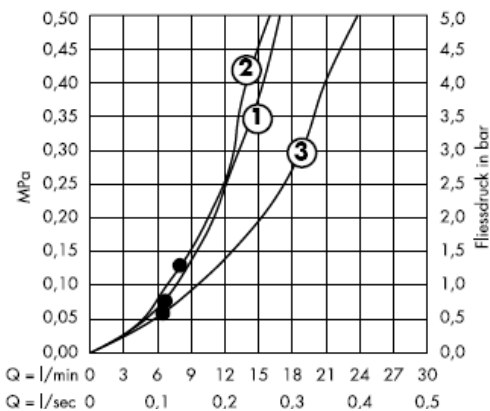

Od • je delovanje zagotovljeno.

Ročna prha je primerna za uporabo s pretočnimi grelniki zmogljivosti nad 21 kW in minimalnim pretokom 7 l/min.

## Čiščenje

Z Rubit®, ročno čistilno funkcijo, lahko s šob očistimo vodni kamen tako, da šobe enostavno podrgnemo.

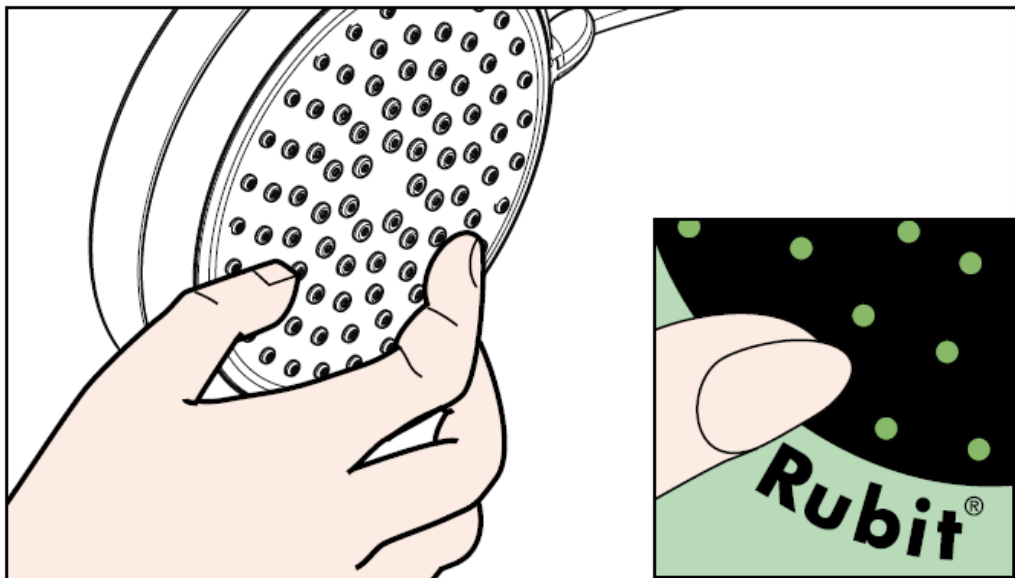

## Čiščenje

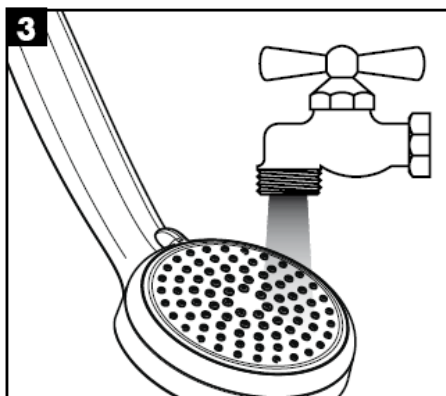
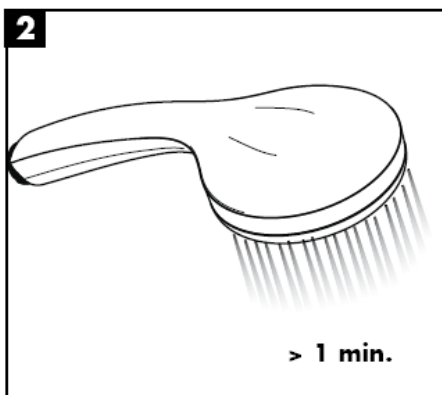
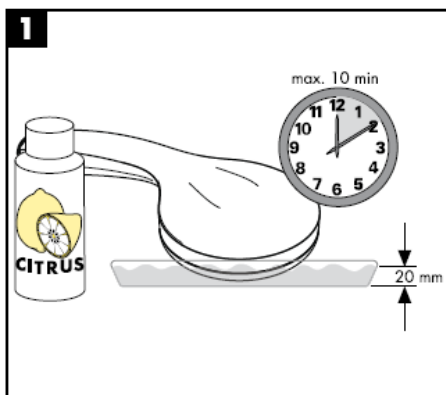
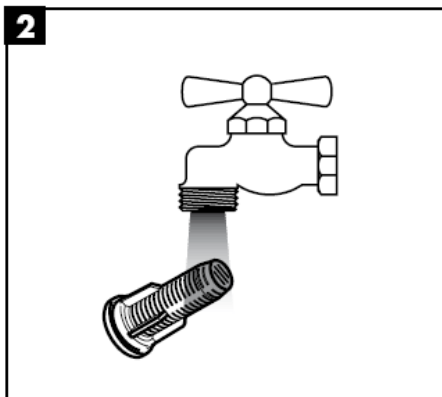
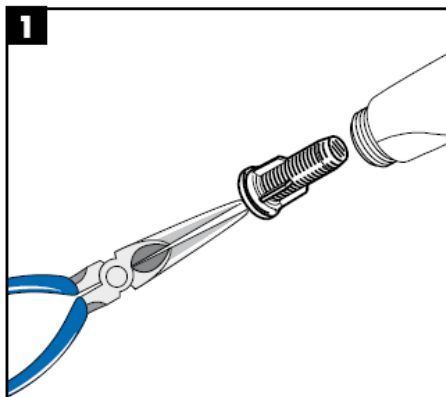

**hansgrohe**





# Paigaldusjuhend

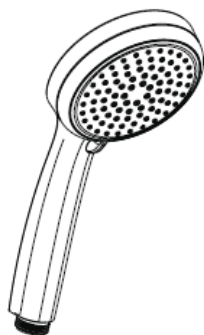

**Croma 100  
Vario**  
28535000



**Croma 100  
Multi**  
28536000

**hansgrohe**

**Croma 100 Vario**  
28535000



Massage



Shampoo



Normal



Rain

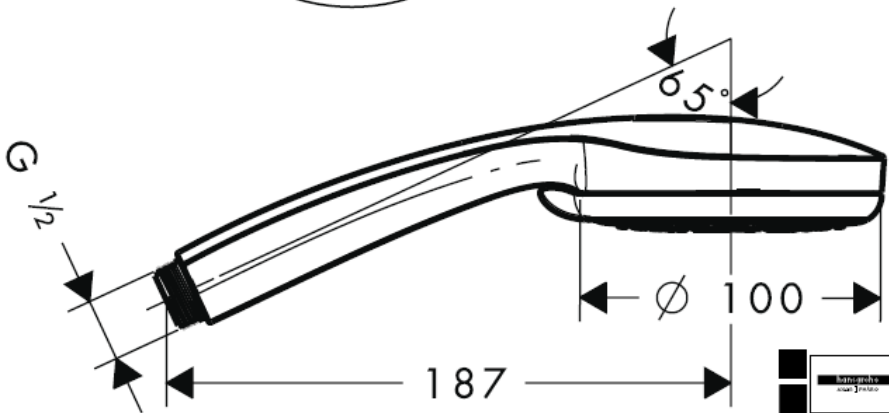

28535000

**Croma 100 Multi**  
28536000



Rain



Mono



Massage

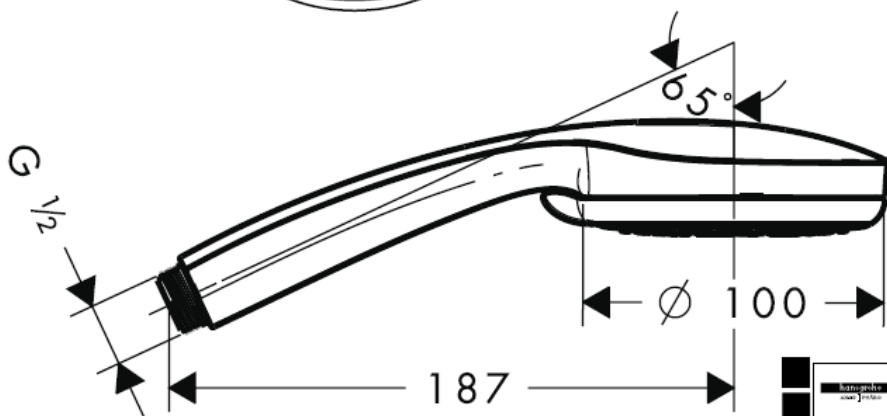

28536000

**Tehnilised andmed**

Töörõhk max. 0,6 MPa  
 Soovitatav töörõhk: 0,1 – 0,4 MPa  
 (1 MPa = 10 baari = 147 PSI)  
 Kuuma vee temperatuur: max. 60° C

	DVGW	P-IX	SVGW	ACS	NF	WRAS	KIWA
28535000		P-IX 18335/ID	X	X			X
28536000		P-IX 18336/ID	X	X			X

**Paigaldamine**

Käsiduši standardse läbivoolu puhul peab veevärgist tuleva mustuse vastu paigaldama kaasasoleva filtri A. Kui soovite suuremat läbivoolu, peab selle asemel kasutama filtrit B. Filtri A või B mittepaigaldamisel käsiduši võib sissetulev mustus funktsioneerimist kahjustada ja/või rikkuda käsiduši detaile. Sellest tulenevate kahjude eest Hansgrohe ei vastuta.

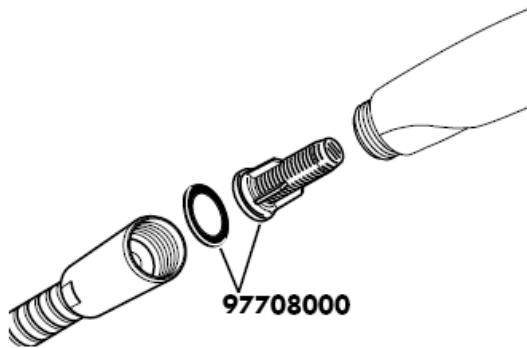

## Croma 100 Vario



Alates • on funktsioneerimine garanteeritud

## Croma 100 Multi

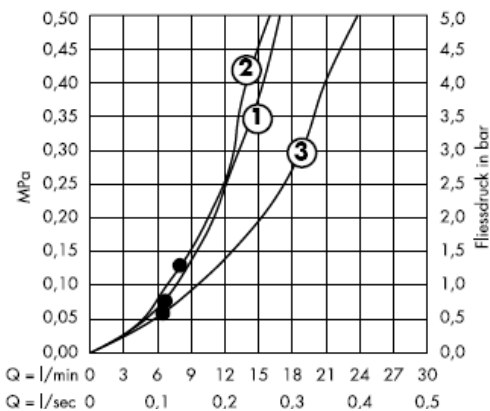

Alates • on funktsioneerimine garanteeritud

Käsidušši sobib kasutada boiler, mille võimsus on alates 21 kW ning minimaalne läbivool 7 l/min.

## Puhastamine

Käsitsi puhastamise funktsiooni Rubit® puhul on vajalik vaid kerge ülehõõrumine, eemaldamaks dušikanalitest katlakivi.

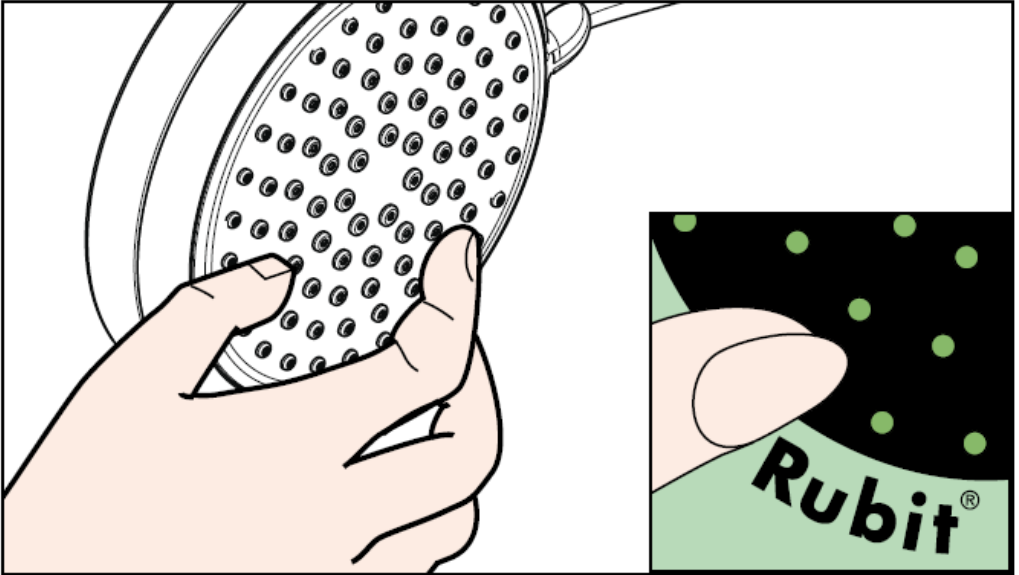

## Puhastamine

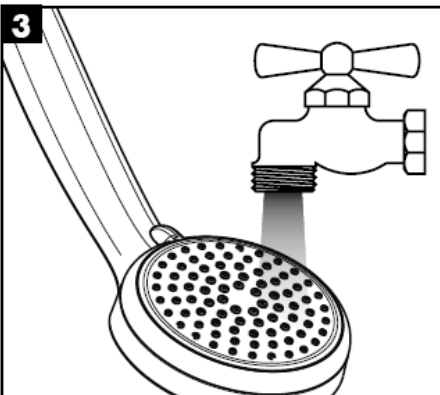
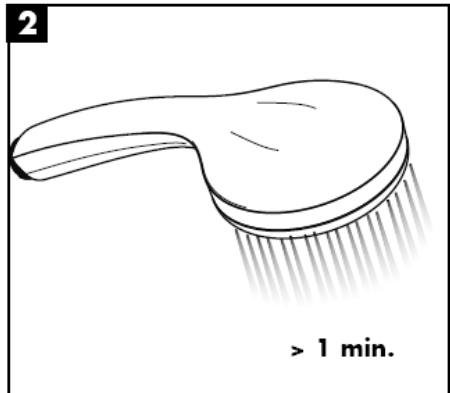
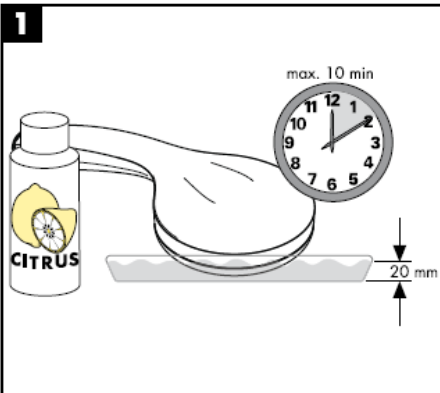
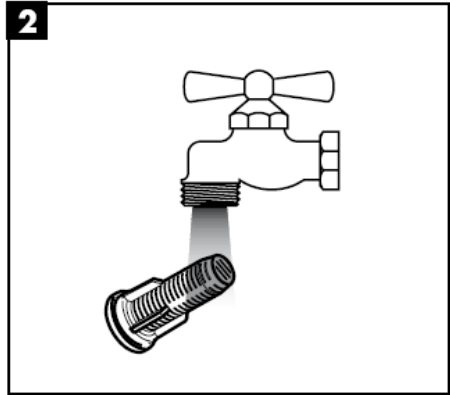
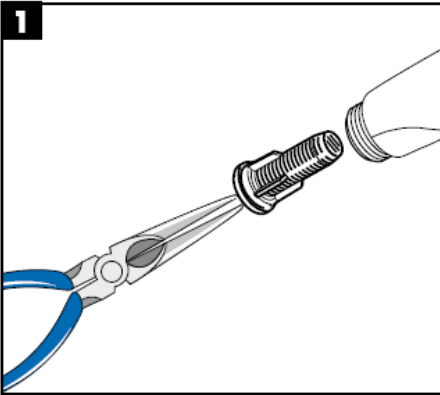

**hansgrohe**





# Montāžas instrukcija

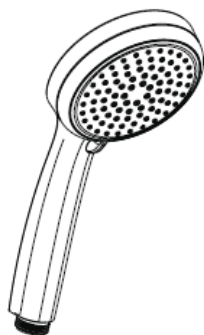

**Cromo 100  
Vario**  
28535000



**Cromo 100  
Multi**  
28536000

**hansgrohe**

**Croma 100 Vario**  
28535000



Massage



Shampoo



Normal



Rain

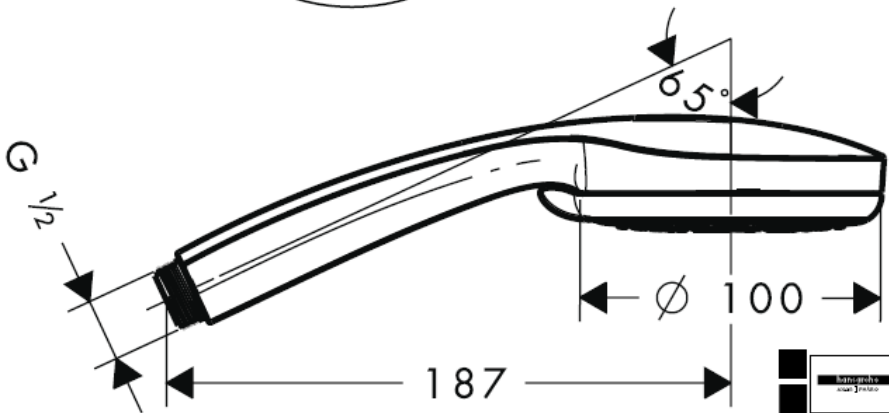

28535000

**Croma 100 Multi**  
28536000



Rain



Mono



Massage

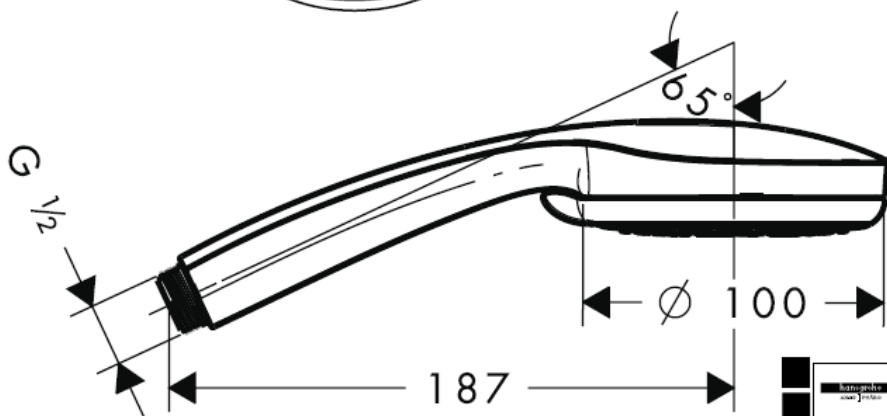

28536000

**Tehniskie dati**

Darba spiediens: max. 0,6 MPa  
 leteicamais darba spiediens: 0,1 – 0,4 MPa  
 (1 MPa = 10 bar = 147 PSI)  
 Karstā ūdens temperatūra: max. 60° C

DVGW	P-IX	SVGW	ACS	NF	WRAS	KIWA
28535000	P-IX 18335/ID	X	X			X
28536000	P-IX 18336/ID	X	X			X

**Montāža**

Lai nodrošinātu rokas dušas normālu ūdens caurplūdi un izvairītos no netīrumu ieskalošanas no ūdensvada, jāiemontē komplektā esošais filtrs (A). Ja ir nepieciešamība pēc lielākas ūdens caurplūdes, tad filtra (A) vietā jāizmanto sietiņš (B). Ieskalotie netīrumi var traucēt dušas funkciju un / vai arī izraisīt rokas dušas funkciju bojājumus, par kuriem Hansgrohe nenes atbildību.

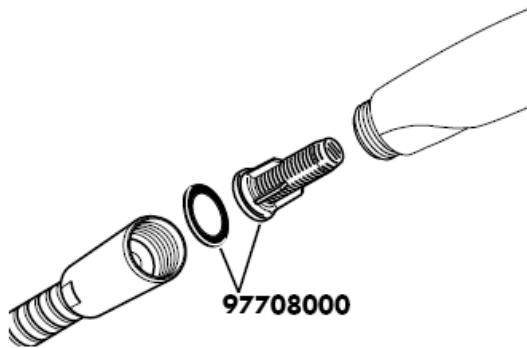

## Croma 100 Vario



No • funkcija nodrošināta

## Croma 100 Multi

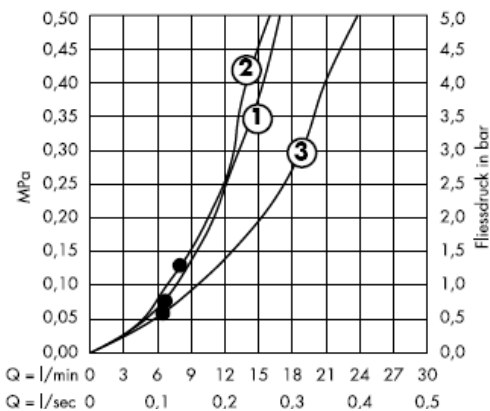

No • funkcija nodrošināta

Rokas duša ir piemērota caurteces sildītājam, kura jauda ir 21 kW un minimālā caurtece 7 l/min.

## Tīrīšana

Rubit® attīrīšanas funkcija - strūklas kanāliņi  
vienkāršas manuālas berzes rezultātā tiek  
attīrīti no kaļķa.

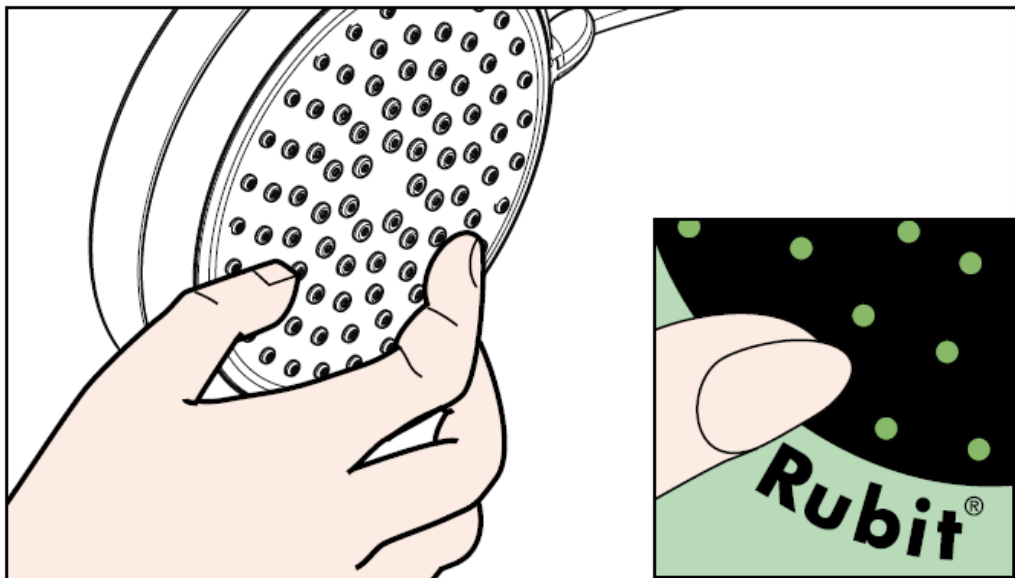

# Tīrīšana

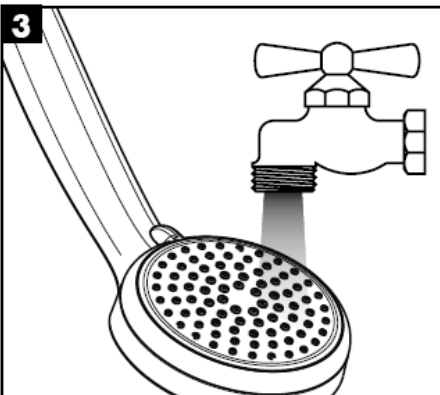
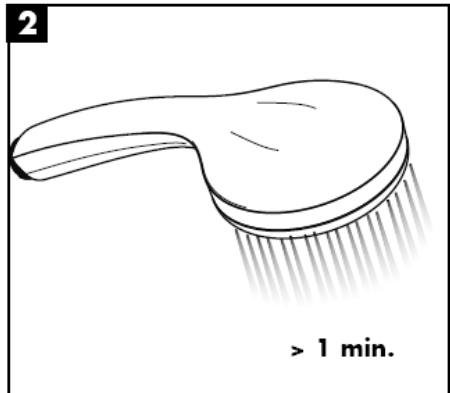
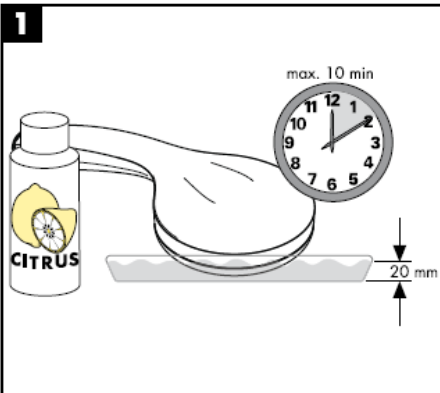
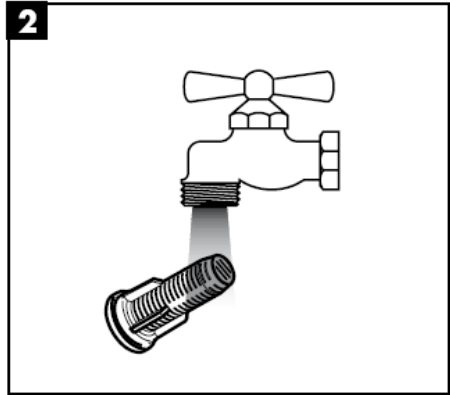
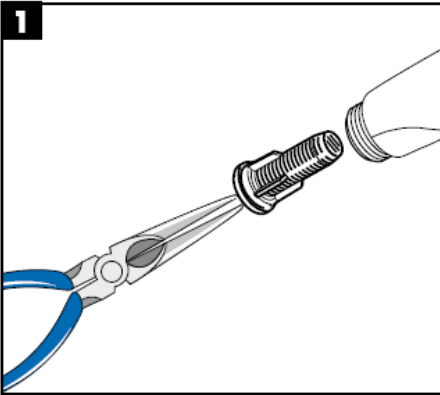

**hansgrohe**





# Uputstvo za montažu

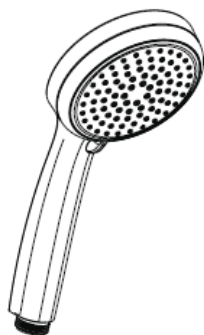

**Croma 100  
Vario**  
28535000



**Croma 100  
Multi**  
28536000

**hansgrohe**

**Croma 100 Vario**  
28535000



Massage



Shampoo



Normal



Rain

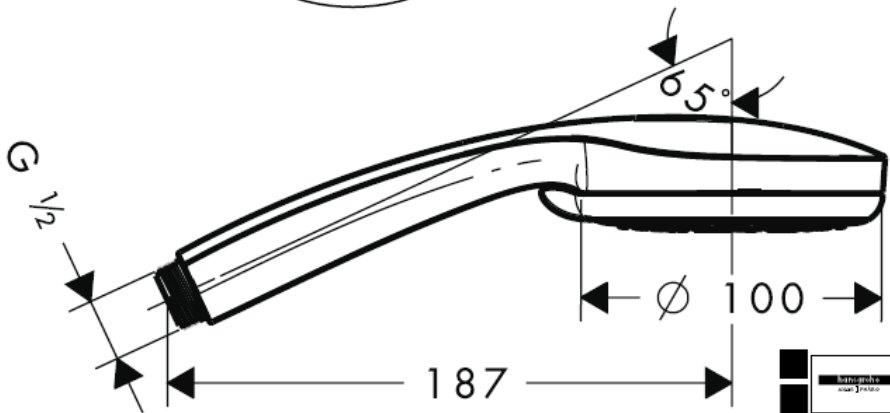

28535000

**Croma 100 Multi**  
28536000

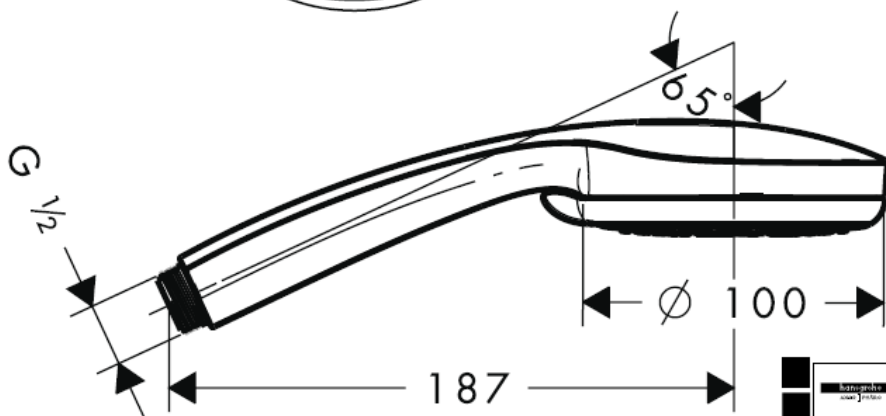

28536000

**Tehnički podaci**

Radni pritisak: max. 0,6 MPa  
 Preporučeni radni pritisak: 0,1 – 0,4 MPa  
 (1 MPa = 10 bara = 147 PSI)  
 Temperatura vruće vode: max. 60° C

	DVGW	P-IX	SVGW	ACS	NF	WRAS	KIWA
28535000		P-IX 18335/ID	X	X			X
28536000		P-IX 18336/ID	X	X			X

**Montaža**

Isporučeni umetak filtra (A) se mora ugraditi kako bi se regulisao protok vode i smanjio prolazak prljavštine iz vodovoda. Ako želite jači protok vode, umesto filtra (A) ugradite mrežastu zaptivku (B).  
 Za eventualna oštećenja ili lošije funkcionisanje ručnog tuša uzrokovano prljavštinom, proizvođač Hansgrohe nije odgovoran.

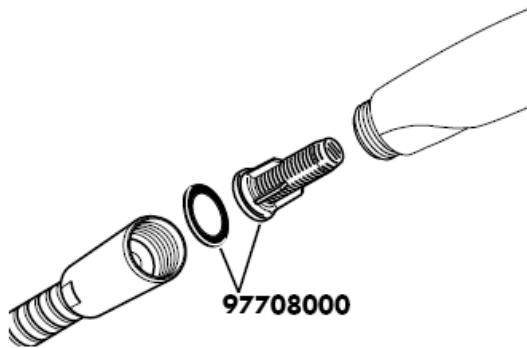

## Croma 100 Vario



Od • je funkcija zagarantovana.

## Croma 100 Multi

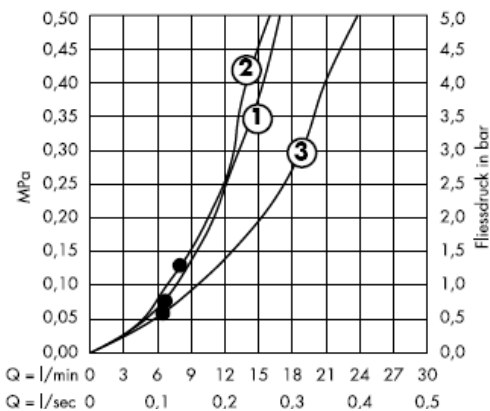

Od • je funkcija zagarantovana.

Ručni tuš možete koristiti uz protočni bojler snage od 21 kW ili veće, te uz minimalni protok od 7 l/min.

## Čišćenje

Rubit® - ručni sistem za čišćenje omogućuje odstranjivanje kamenca s rupica uobličavača mlaza, jednostavnim trljanjem.

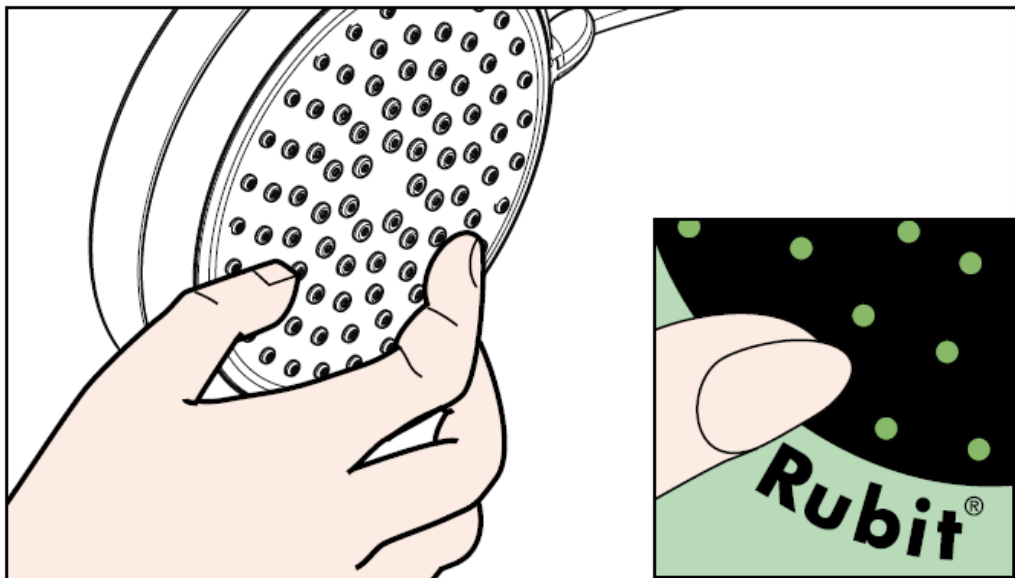

## Čišćenje

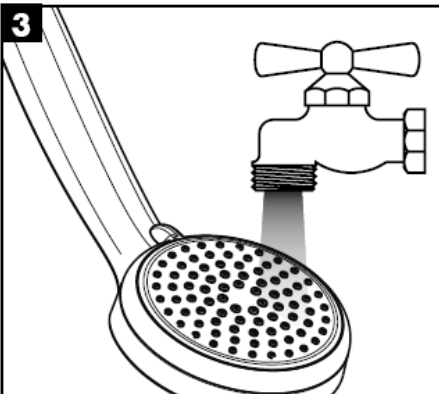
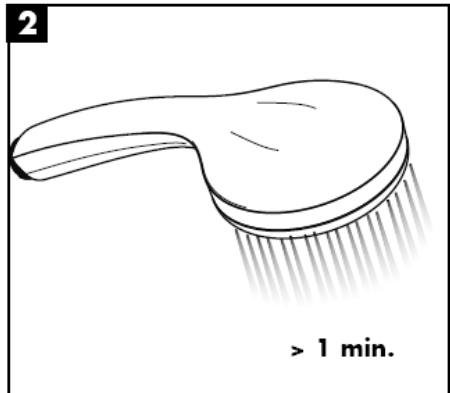
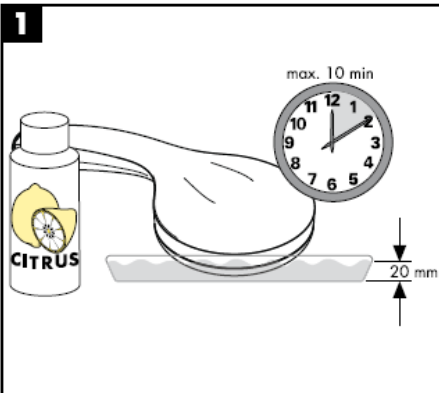
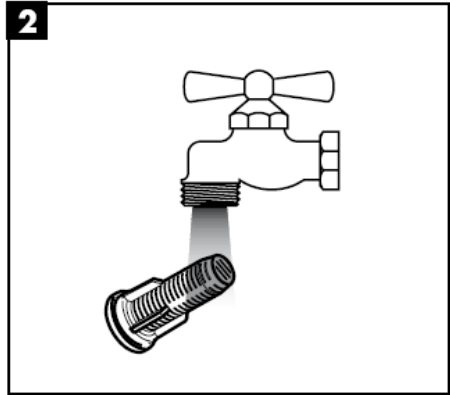
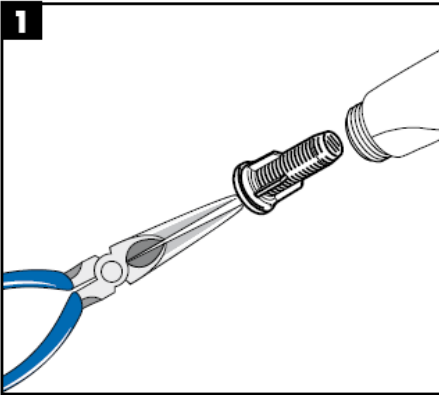

**hansgrohe**





# Montasjeveiledning

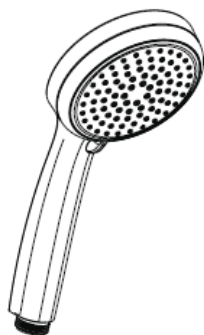

**Cromo 100  
Vario**  
28535000



**Cromo 100  
Multi**  
28536000

**hansgrohe**

**Croma 100 Vario**  
28535000

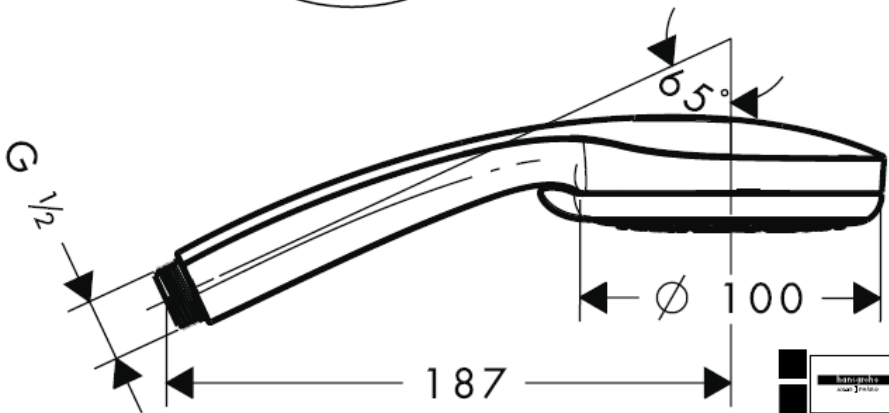

28535000

**Croma 100 Multi**  
28536000

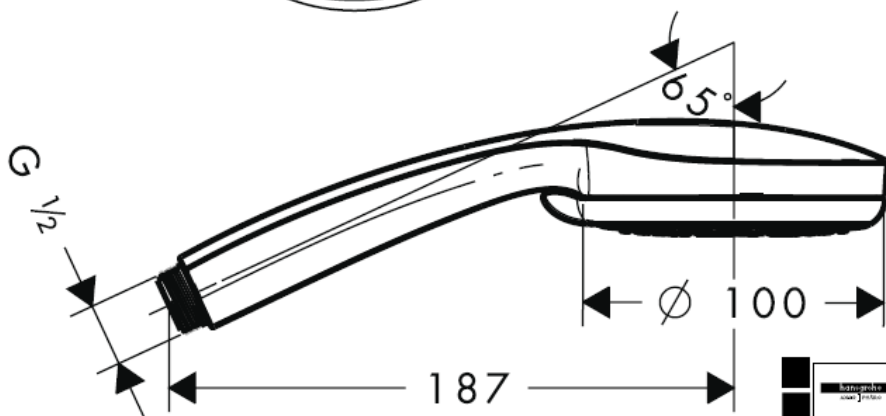
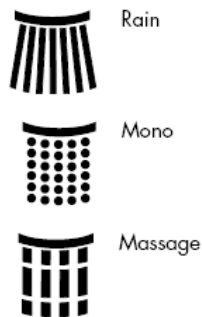

28536000

**Tekniske data**

Driftstrykk	max. 0,6 MPa
Anbefalt driftstrykk: (1 Mpa = 10 bar = 147 PSI)	0,1 – 0,4 MPa
Varmtvannstemperatur	max. 60° C

	DVGW	P-IX	SVGW	ACS	NF	WRAS	KIWA
28535000		P-IX 18335/ID	X	X			X
28536000		P-IX 18336/ID	X	X			X

**Montasje**

Det medleverte filter-elementet skal bygges inn, for å garantere hånddusjens standard-gjennomstrømning og for å forhindre at smuss spyles inn fra ledningsnettet. Ønsker man en større vanngjennomstrømning skal det monteres en silpakning (B) isteden for filterelementet (A). Innspyling av smuss kan påvirke funksjonen negativt og/eller medføre skader på hånddusjens funksjonsdeler. Hansgrohe påtar seg inget ansvar for skader som resulteres av dette.

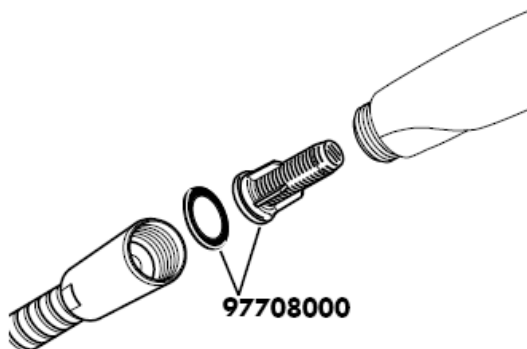

## Croma 100 Vario

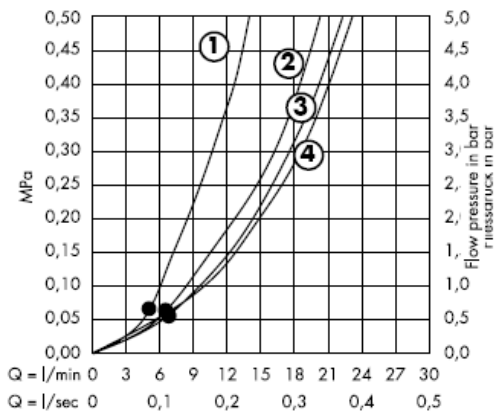

F.o.m. • er funksjonen garantert

## Croma 100 Multi

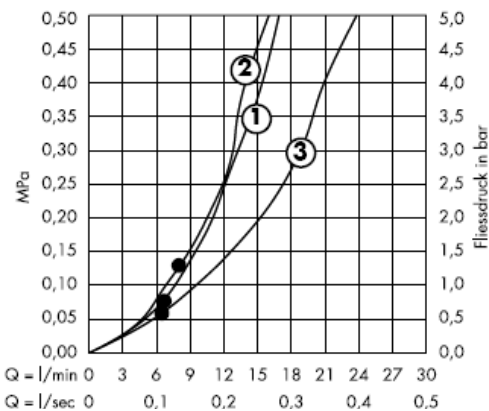

F.o.m. • er funksjonen garantert

Hånddusjen egner seg for bruk sammen med en gjennomstrømningsovner fra og med en ytelse på 21 kW og en minimum gjennomstrømning på 7l/min.

## Rengjøring

Ved hjelp av Rubit®, en manuell rengjøringsfunksjon, kan man fjerne kalk fra stråleformere ved enkel gnikking.

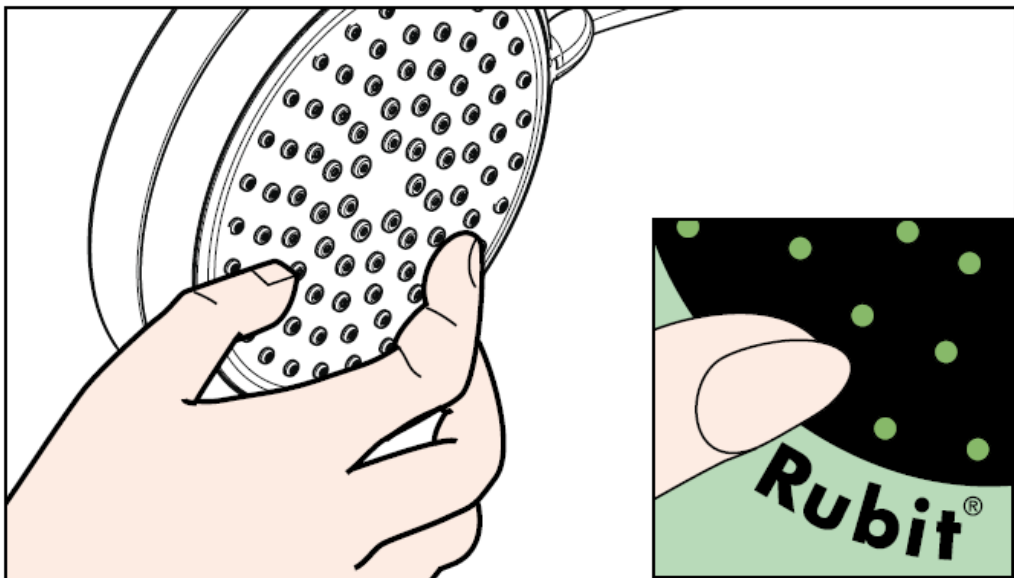

## Rengjøring

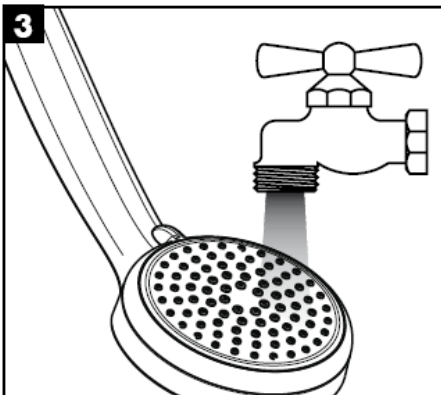
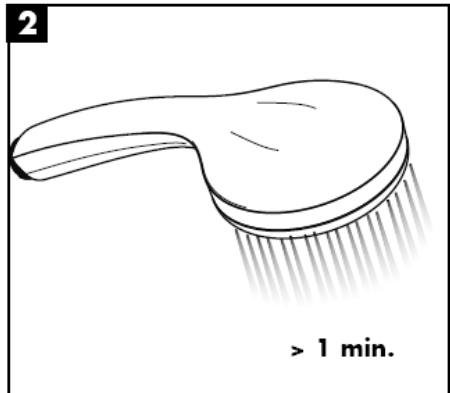
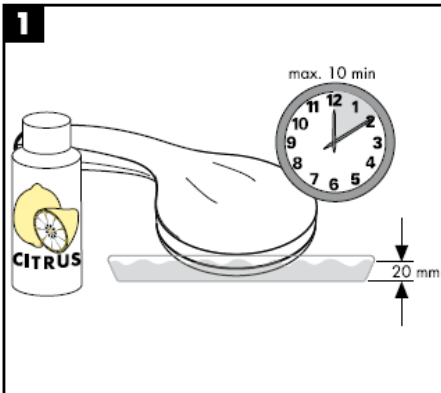
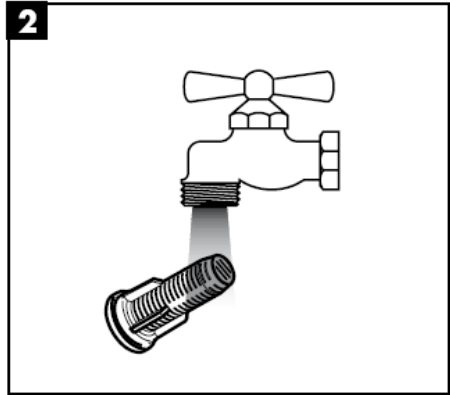
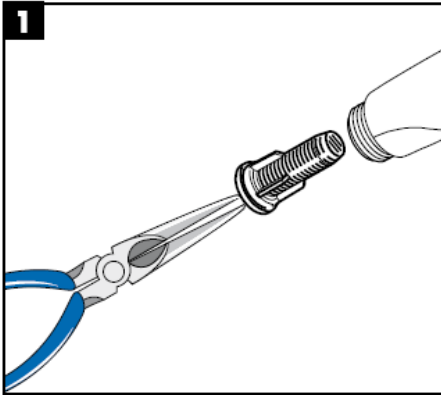

**hansgrohe**





# РЪКОВОДСТВО ЗА МОНТАЖ

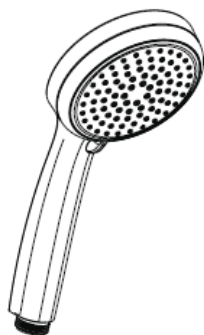

**Croma 100  
Vario**  
28535000

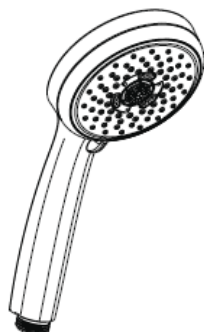

**Croma 100  
Multi**  
28536000

**hansgrohe**

**Croma 100 Vario**  
28535000

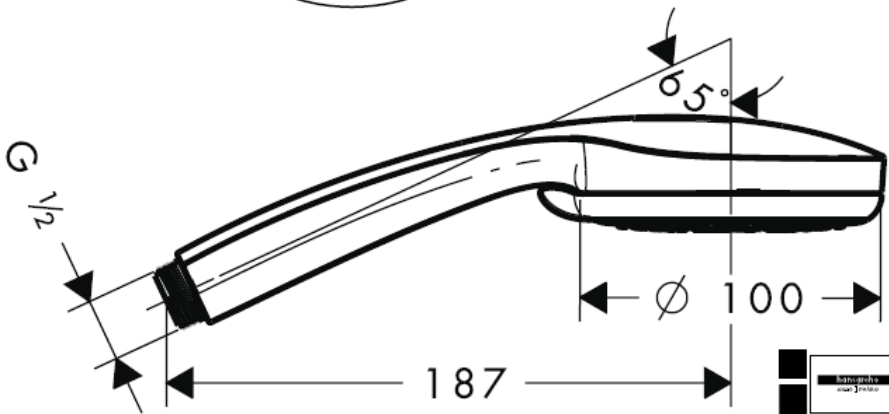
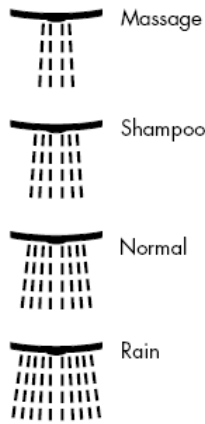

28535000

**Croma 100 Multi**  
28536000



Rain



Mono



Massage

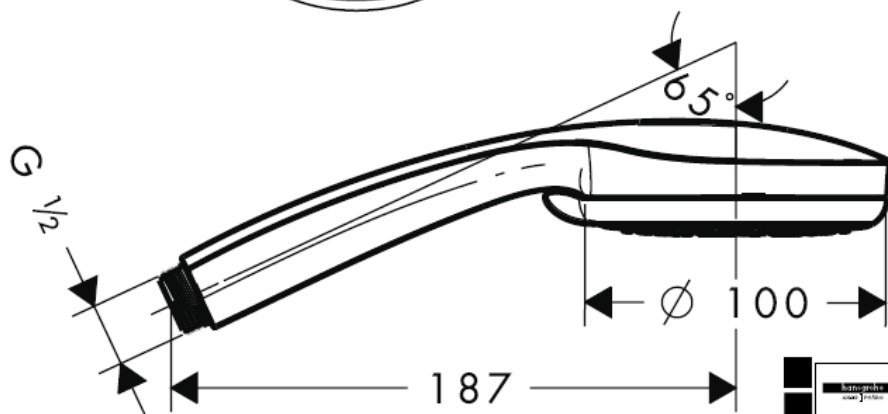
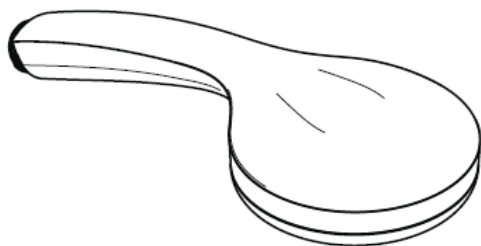

28536000

**Технически данни**

Работно налягане: max. 0,6 МПа  
 Препоръчително работно налягане: 0,1 – 0,4 МПа  
 (1 МПа = 10 bar = 147 PSI)  
 Температура на горещата вода: max. 60° C

	DVGW	P-IX	SVGW	ACS	NF	WRAS	KIWA
28535000		P-IX 18335/ID	X	X			X
28536000		P-IX 18336/ID	X	X			X

**Монтаж**

Опакованата към него филтърна вложка (А) трябва да се монтира, за да се осигури нормалния поток към ръчния разпръсквател и да се избегне натрупване на замърсявания от водопроводната мрежа. Ако желаете по-силно протичане на вода, вместо филтърната вложка (А) поставете уплътнението с цедка (В). Натрупването на замърсявания може да наруши функцията и/или да доведе до увреждания на функционалните части на ръчния разпръсквател, Hansgrohe не носи отговорност за получените се по този начин щети.

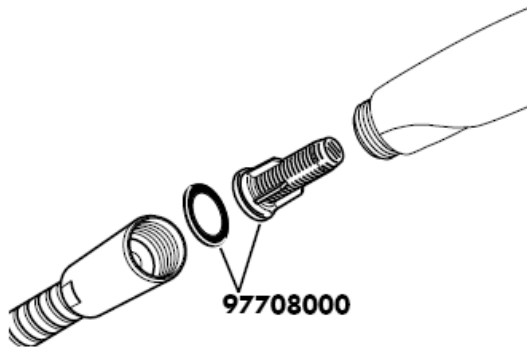

## Croma 100 Vario



От • функцията е гарантирана.

## Croma 100 Multi

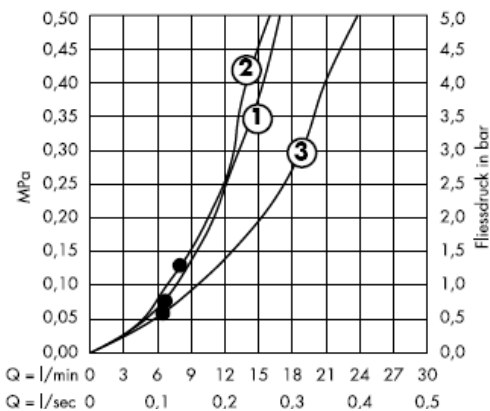

От • функцията е гарантирана.

Ръчният разпръсквател е подходящ за използване с проточни нагреватели с мощност от 21 kW нагоре и минимален поток от 7 л/мин.

## Почистване

С Rubit®, ръчната функция за почистване, приспособленията за почистване на струята могат да се почистват от варовика с просто разтъркване.

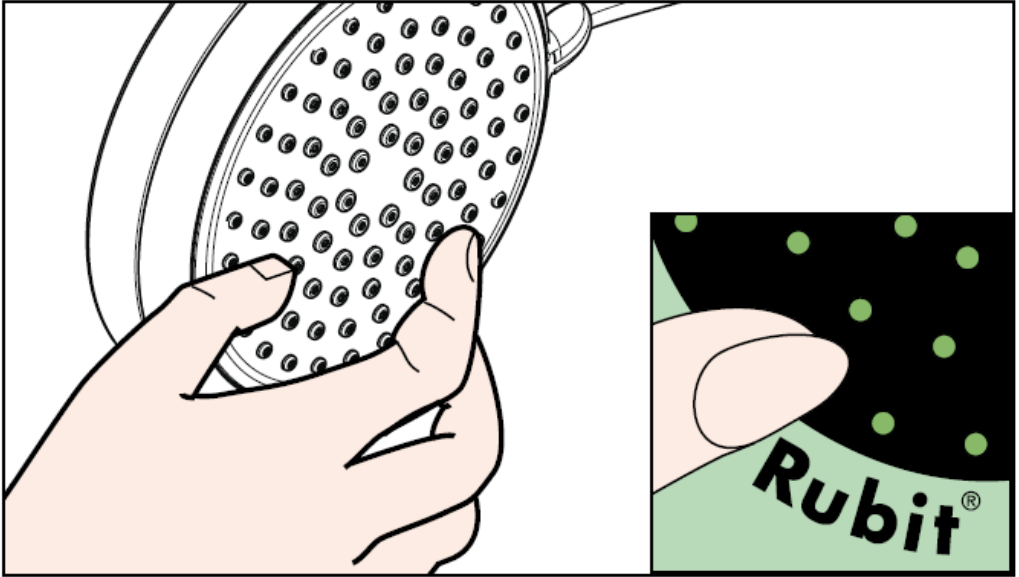

## Почистване

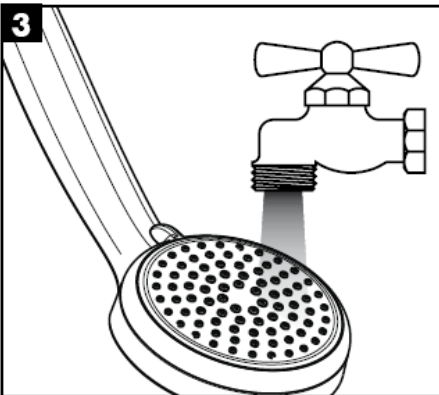
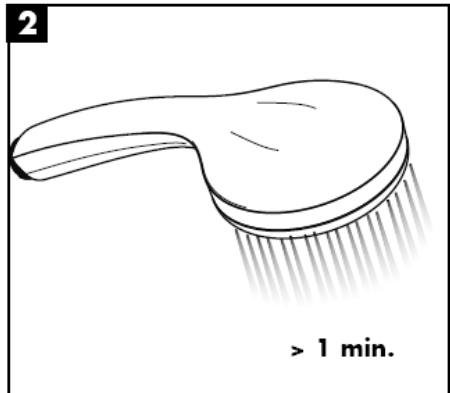
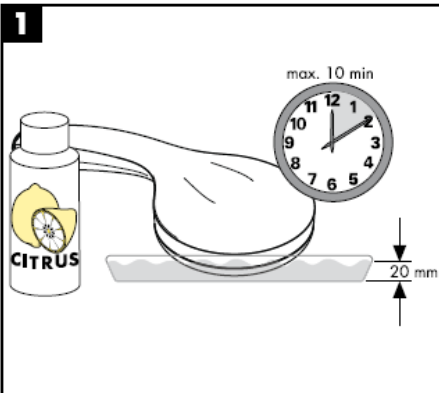
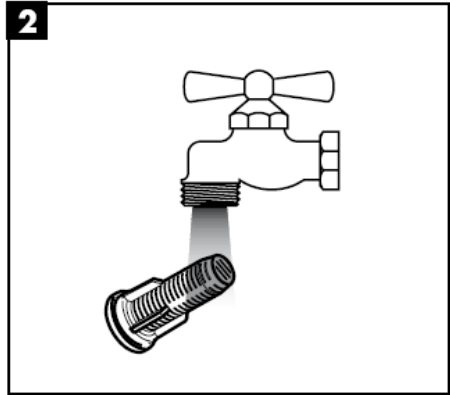
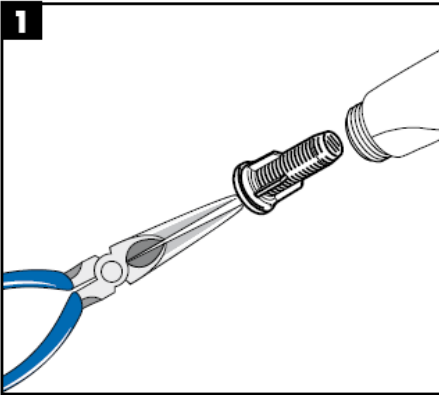

**hansgrohe**





# Udhëzime rreth montimit

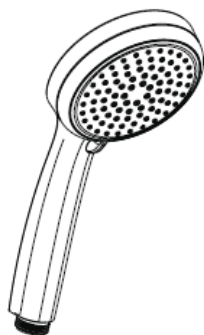

**Cromo 100  
Vario**  
28535000



**Cromo 100  
Multi**  
28536000

**hansgrohe**

**Croma 100 Vario**  
28535000



Massage



Shampoo



Normal



Rain

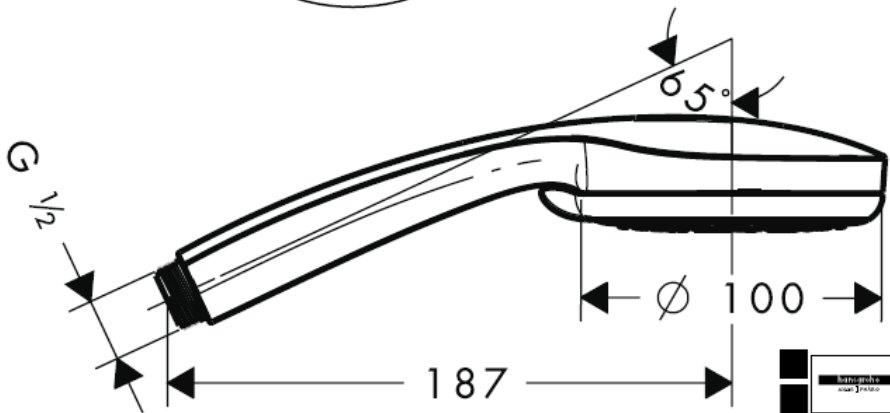

28535000

**Croma 100 Multi**  
28536000

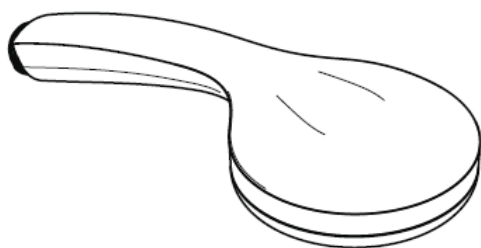
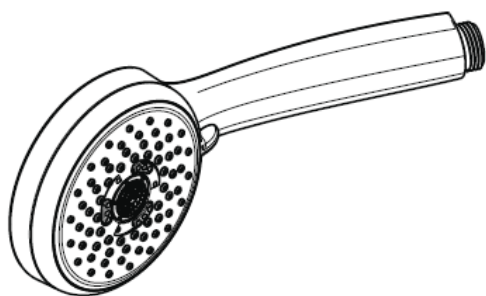

Rain



Mono



Massage

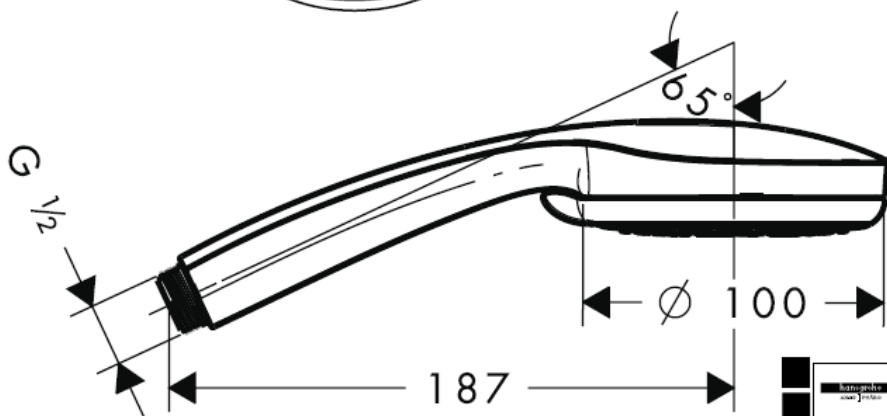

28536000

**Të dhëna teknike**

Presioni gjatë punës max. 0,6 MPa  
 Presioni i rekomanduar: 0,1 – 0,4 MPa  
 (1 MPa = 10 bar = 147 PSI)  
 Temperatura e ujit të ngrëhtë max. 60° C

	DVGW	P-IX	SVGW	ACS	NF	WRAS	KIWA
28535000		P-IX 18335/ID	X	X			X
28536000		P-IX 18336/ID	X	X			X

**Montimi**

Filtri i bashkëngjitur (A) duhet montuar për të garantuar rrjedhjen sipas normave të ujit nga spërkatësja si dhe për të evituar thithjen e ndotjeve nga tubacionet e ujësjellësit. Nëse dëshironi më shumë vëllim uji, atëherë në vend të filtrit (A) duhet të përdorni sitën (B). Ndotjet mund të dëmtojnë pjesë funksionale të spërkatëses. Hansgrohe nuk merr përgjegjësinë për dëmet e shkaktuara në këtë mënyrë.

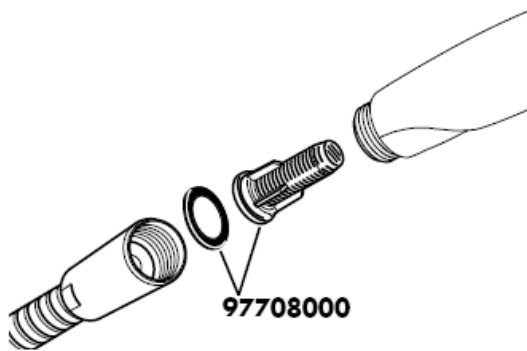

## Croma 100 Vario



Nga • është i mundur funksioni.

## Croma 100 Multi

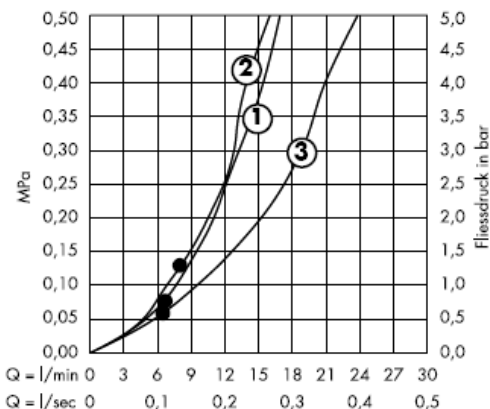

Nga • është i mundur funksioni.

Spërkatësja mund të përdoret në kombinim me ngrohës elektrikë të ujit me kapacitet 21 kW e sipër dhe një rrjedhje minimale prej 7 l/min.

## Pastrimi

Me Rubit®, funksionin manual të pastrimit mund të hiqet kalku me fërkim të thjeshtë nga formuesit e currilit.

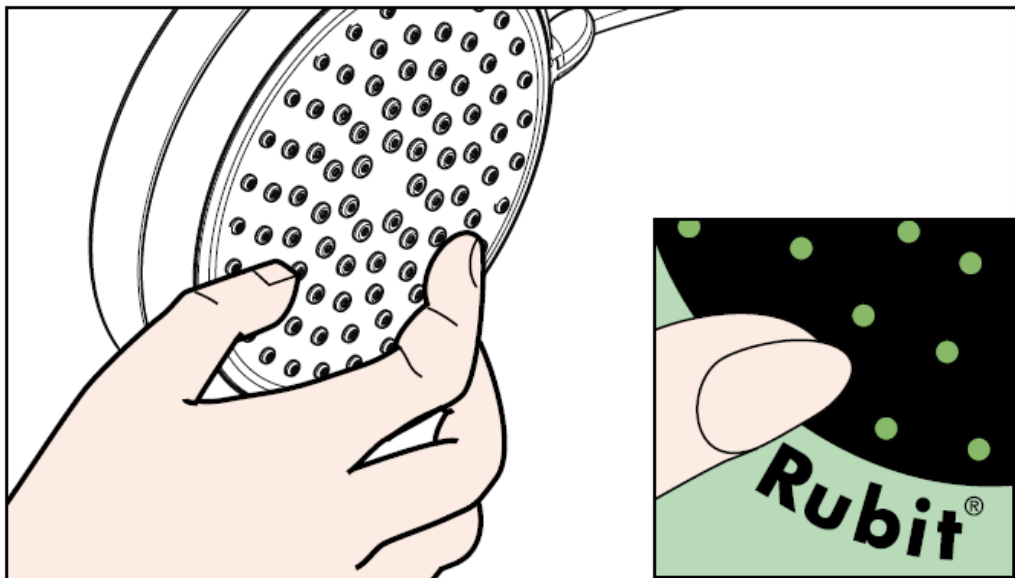

# Pastrimi

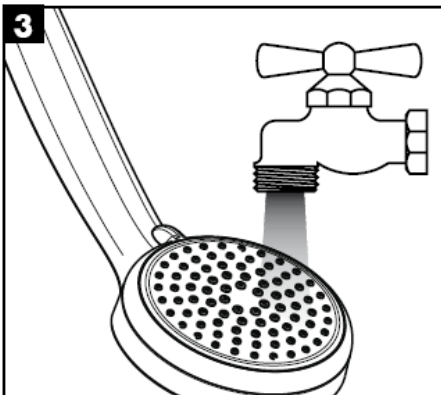
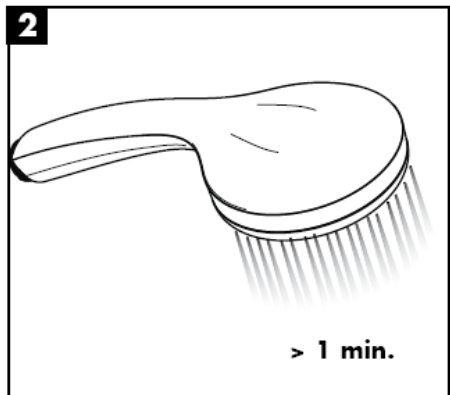
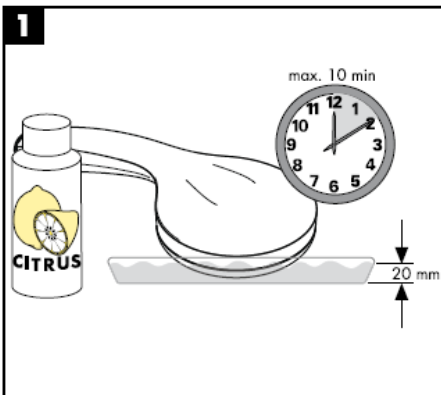
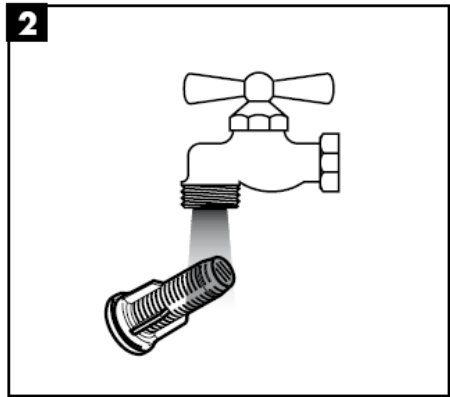
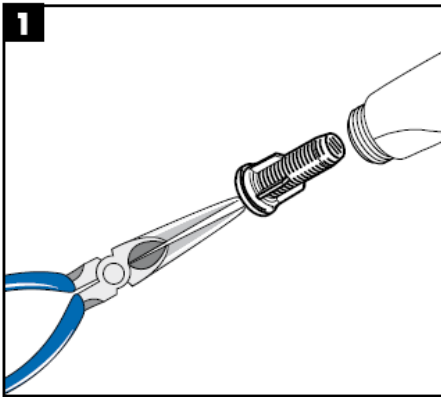

**hansgrohe**

